

Operating instructions

**DELCO 3100 electronics**  
**with base load selection circuit (option)**  
**for stationary, speed-controlled,**  
**screw compressors (LSR series)**

Valid from software edition SD31S1.xx

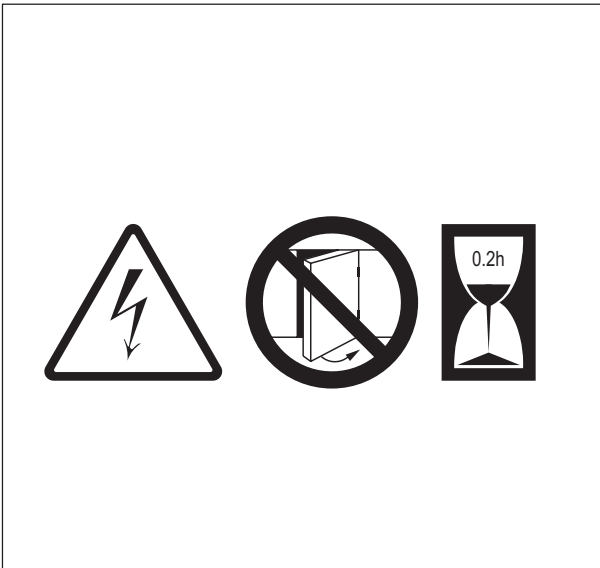

**Attention:** Risk of electroshock due to charged capacitors!

Always disconnect the system from the power supply and wait for 12 minutes before touching electrical components.

This time is required by the power capacitors for discharging!

<b>1.</b>	<b>DELCO 3100 electronics LSR .....</b>	<b>5</b>
1.1	Operating elements .....	5
1.1.1	Keyboard .....	5
1.1.2	Light emitting diodes .....	6
1.1.3	Language selection .....	7
1.1.4	Clear text field - Line 1 .....	7
1.1.5	Clear text field - Line 2 status display .....	7
1.2	Menu structure DELCO 3100 (examples) .....	10
1.2.1	Menu [MAINTENANCE SCHED.] .....	11
1.2.2	Menu [CONTROL MENU] .....	11
1.2.3	Menu [FAULT MEMORY] .....	11
1.2.4	Menu [LIMIT VALUES] .....	12
1.2.5	Menu [OPTIONAL INPUTS] .....	12
1.2.6	Menu [TIMER CONTROL] .....	12
1.2.7	Changing of values .....	14
1.2.8	Locking/unlocking of the code .....	14
1.2.9	Setup code .....	15
1.3	Commissioning .....	15
1.3.1	Starting of the unit .....	15
1.3.2	Regulation .....	15
1.3.3	Operation under load/idle running .....	16
1.3.4	Stopping of the unit .....	16
1.3.5	Malfunction/shutdowns/power failures .....	16
1.3.6	Warning .....	16
1.3.7	Maintenance .....	16
1.3.8	Collective fault relay .....	16
1.3.9	Motor on .....	16
1.3.10	Operating .....	16
1.3.11	Operating/load hours counter .....	16
1.3.12	Fault memory .....	16
1.4	Fault table DELCO 3100 in the case of a fault or warning .....	17
1.4.1	Check list .....	17
1.4.2	Table of faults/warnings .....	17
1.5	Maintenance intervals .....	27
1.6	Operating modes .....	27
1.6.1	Automatic and continuous operation .....	27
1.6.2	Setting of the flow unit for the status display [DISPLAY UNITS = m <sup>3</sup> /min] .....	27
1.6.3	Speed limitation .....	27
1.6.4	Remote control (remote ON/OFF) .....	27
1.6.5	Remote control (pressure changeover) .....	28
1.6.6	Automatic restart after power failure .....	28
1.6.7	Unlimited automatic restart after power failure .....	28
1.6.8	RS485 communication .....	29
1.7	Factory pre-set limit values .....	29

<b>2.</b>	<b>Base load selection circuit DELCOS 3100 LSR</b>	<b>30</b>
2.1	Overview	30
2.2	Functional description / features	30
2.3	Interfacing the slaves with the BLS	31
2.3.1	Load requirement	31
2.3.2	Fault message	31
2.4	Interfacing the master with the BLS	31
2.5	Remote control	31
2.5.1	Remote pressure change-over	31
2.5.2	Remote switching off in [OPERATION ON]	31
2.5.3	Remote switching on in [OPERATION TIMER]	31
2.6	Overview [BASE LOAD SELECT.] menu	32
2.6.1	Notes on the setting	32
2.6.2	Data saving	32
2.6.3	Setting [OPERATION]	33
2.6.4	Setting [CUT-OUT POINT / TARGET PRESSURE]	33
2.6.5	Setting [BASE LOAD COMP]	33
2.6.6	Status display of the BLS [123h K1 K3 k4 r2 r5]	34
2.6.7	Setting [CHANGEOVER TIME]	34
2.6.8	Setting [QUANT. OF BLS SLAVES]	34
2.6.9	Setting [QUANT. OF RESERVE]	34
2.6.10	Setting [VOL.COMP 2.5]	34
2.6.11	Setting [SWITCH OFF DELAY]	35
2.6.12	Setting [START DELAY]	35
2.6.13	Setting [LOAD NET IN]	35
2.6.14	Setting [NET VOLUME]	35
2.7	Change-over of BLS series	36
2.8	Compressor fault	36
2.9	Message BLS active	37
2.9.1	Via the output Spare-Out (option)	37
2.9.2	Via the BLS module	37
2.10	Messages to the higher-level system when BLS is not activated	37
<b>3</b>	<b>Analogue output (option)</b>	<b>37</b>

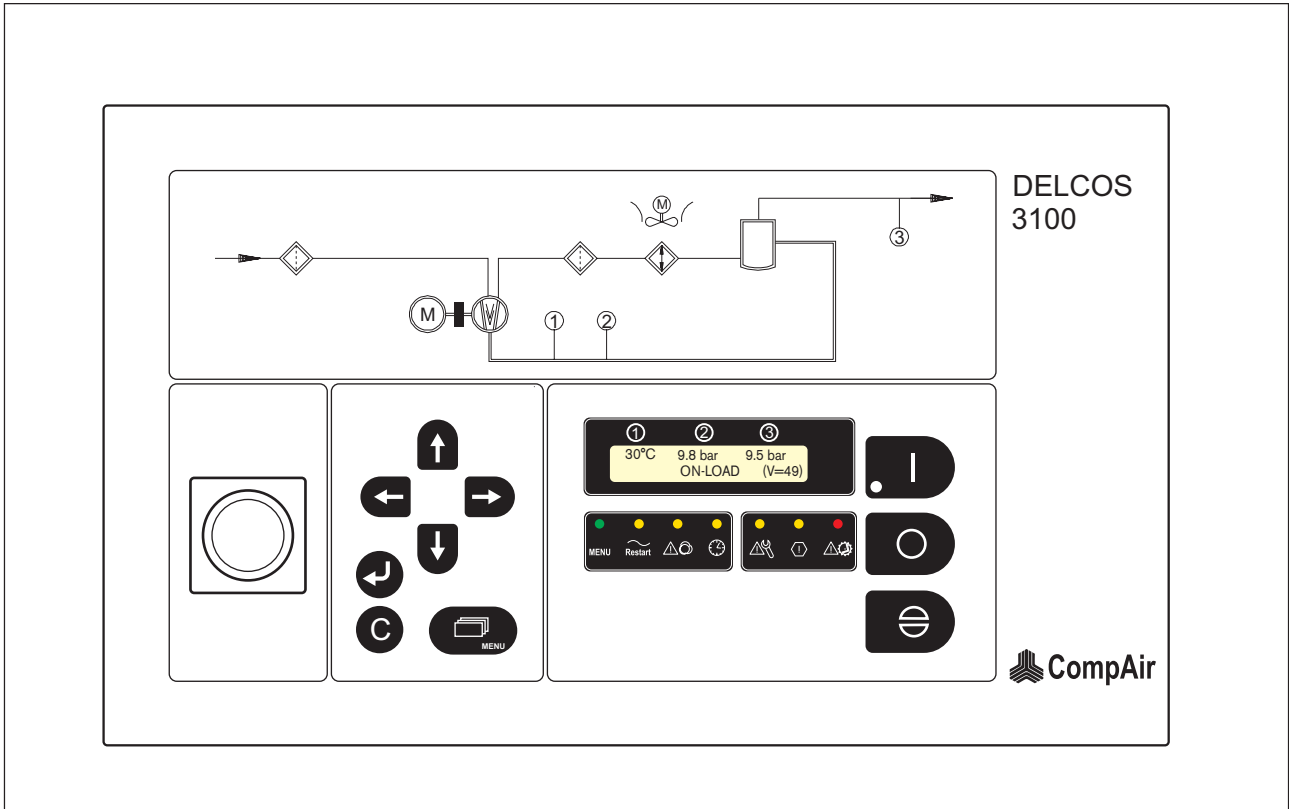

Fig. 1

## 1.1 Operating elements

### 1.1.1 Keyboard



=> Switches the system on



=> Switches the system off



=> Acknowledgement key  
=> in the menu: Input mode interrupted (previous value is restored)

Clear text field: => 1st line: Indication of final temperature/final compression pressure/line pressure  
=> 2nd line: Status display (operating mode)



=> Opens/closes the menu



=> Input of an access code which protects various menu items



=> In the menu: scrolling upwards  
In the input mode: changing of parameters



=> In the menu: scrolling downwards  
In the input mode: changing of parameters



=> One column to the left in the menu



=> One column to the right in the menu



=> Inputs are to be changed or acknowledged

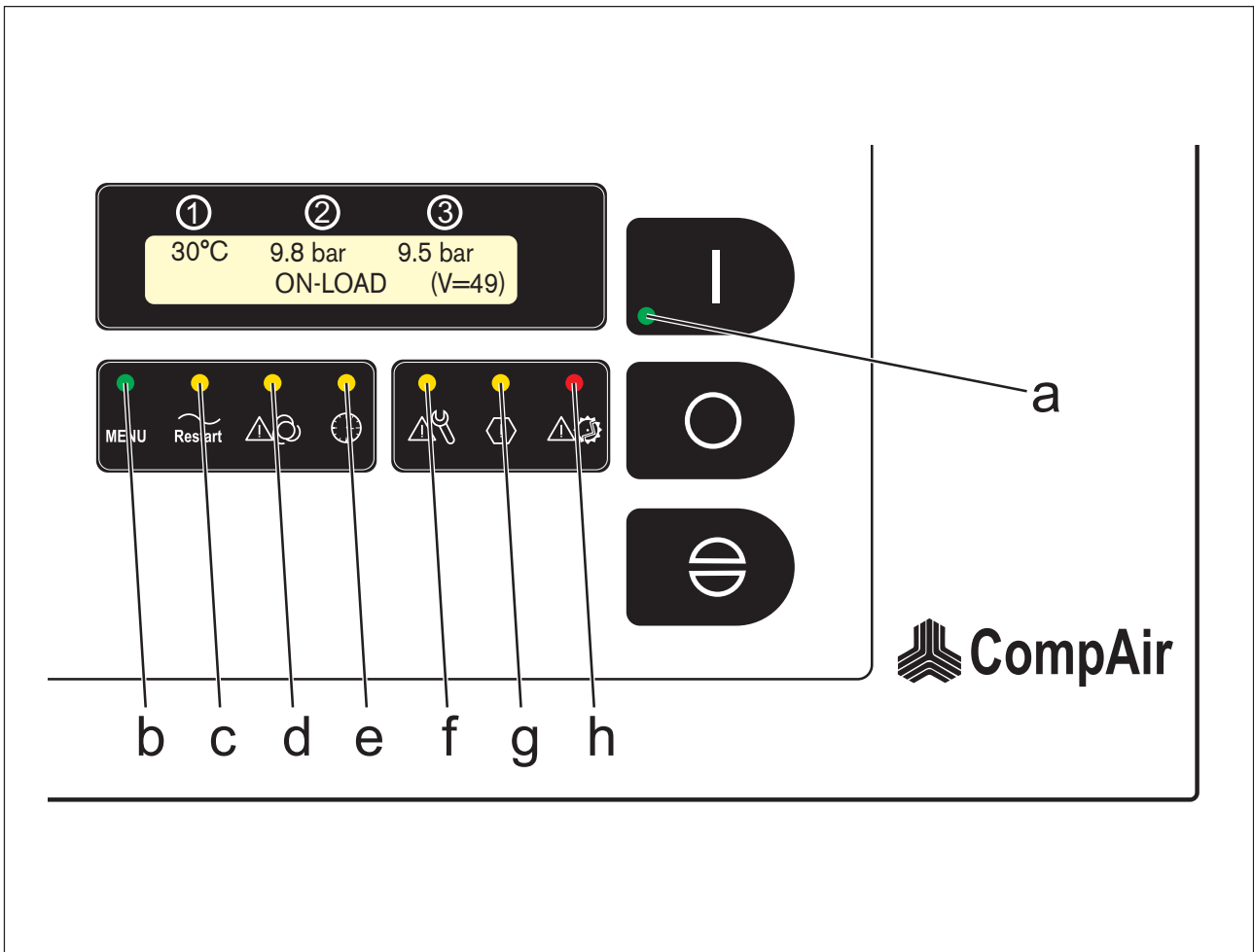

Fig. 2

### 1.1.2 Light emitting diodes

#### Operating messages:

LED a	=> flashing:	The system is in the stand-by mode, i.e. the motor can start up automatically at any time.
	on:	The drive motor is running
LED b	=>	The operator is within the menu
LED c	=>	Automatic restart is switched ON
LED d	=> flashing:	Remote control, remote off
	on:	Remote control, remote on



LED e	=> flashing:	In timer control mode Compressor OFF
	on:	In timer control mode Compressor ON

#### Messages:

LED f	=>	Maintenance interval elapsed
LED g	=>	Warning
LED h	=>	Collective fault

If LED f, g or LED h light up, a message will appear in the clear text field. Determine the cause of failure, warning or maintenance as described in the following chapters - 1.3.5 to 1.3.12.

### 1.1.3 Language selection

DELCOS 3100 is provided in 17 languages. You can change from one language to the other by pressing keys  and  simultaneously. The internationally valid, national symbols show the current configuration.

**Note**

*The change-over of language is not possible within the menu status (LED b => OFF).*

*In the English display variant you can select °C, bar or °F,PSI.*

### 1.1.4 Clear text field - Line 1

Under normal operating conditions, the display shows the following system values in line 1 of the clear text field:

- 1 => Final temperature (Sensor R2),
- 2 => Final compression pressure (Sensor B2)
- 3 => Line pressure (Sensor B1)

In the case of incorrect transmission from a sensor, the actual value cannot be determined and displayed. The display shows: - - - - as well as a corresponding message in the second line: FAULT SENSOR ....

#### Final temperature display

This display indicates the final compression temperature.

If the temperature is too high, the temperature display flashes.

#### Final compression pressure display

This display indicates the final compression pressure (see above).

If the system pressure/final compression pressure is too high, the display flashes (see above).

#### Line pressure display

This indicates the actual mains pressure.

### 1.1.5 Clear text field - Line 2 status display

The 2nd line of the clear text field shows the relevant status of the machine, which can be overwritten permanently in the case of faults or cyclically in the case of warnings or maintenance.

The status displays listed below have the following meaning:

**INITIALIZATION SRD ...**

The supply voltage of the unit was switched on. The control is initialised and establishes the communication with the SR drive.

**SRD-POWERING UP... xxxVDC**

The DC intermediate circuit of the SR drive is being charged. The voltage is xxx VDC.

**READY TO START**

The unit is ready to start, but is yet switched off

**WARNING START WITH ...**

alternating with

**... PRESSURE REQUIREMENT**

The unit has been switched on (stand-by); a line pressure requirement is missing !

**WARNING START AFTER ...**

alternating with

**... DE-PRESSURISE**

The unit has been switched on (stand-by); the final compression pressure is still above the start-up protection value.

**WARNING START WITH ...**

alternating with

**... TIMER CONTROL**

The unit has been switched on in the "timer control" operating mode (stand-by). The enable signal from the timer is not yet available.

**WARNING START BY ...**

alternating with

**... REMOTE OPERATION**

The remote control operating mode is activated. The start-up takes place with the REMOTE ON signal.

## 1. DELCOS 3100 electronics LSR

### WARNING START IN xxxs

alternating with

### ... AFTER POWER LOSS

Restart with time delay in xxx seconds as a result of "AUTO RESTART" after power failure

### CAUTION: START IN xx MIN ...

alternating with

### ... AFTER DRYER PRE-RUN

The unit was switched on (stand-by); the dryer is still in the pre-run time. The start-up will place when this time has elapsed.

### MOTOR START PHASE

Motor starts up

*The status line shows the volume delivered in the operational states of the off-load and on-load mode. If the base load selection circuit is active, the total volume delivered can be displayed additionally.*

The delivered volume can be displayed

- as value of the individual machine
- as value of the complete station (not possible with [BASE LOAD SELECT OPERATION OFF])

To change the contents in brackets, scroll through the individual items and make the changes by means of the arrow keys.

- Value for the individual machine

### OFF-LOAD (V = 0.0) 123s

The machine is running in the off-load mode at minimum speed and will be shut down in 123 seconds.

### ON-LOAD (V = 4.9)

The machine is running in the on-load mode. It delivers 4.9 m<sup>3</sup>/min.

### ON-LOAD (V = 294)

As before, but unit of the delivered volume = m<sup>3</sup>/h.

- Value for the complete station

### OFF-LOAD ( $\Sigma V = 23.0$ ) 123s

The machine is running in the off-load mode at minimum speed and will be shut down in 123 seconds.

The active slave compressors deliver a total volume of 23 m<sup>3</sup>/min.

### ON-LOAD ( $\Sigma V = 27.9$ )

The machine is running in the on-load mode. The total volume delivered is 27.9 m<sup>3</sup>/min.

### ON-LOAD ( $\Sigma V = 1674$ )

Like before, but unit of the delivered volume = m<sup>3</sup>/h.

### Note

If the RUN-ON TIMER (e.g. 123s) is not displayed while the machine is in the off-load mode, CONTINUOUS OPERATION was activated instead of AUTOMATIC OPERATION (compressor shuts down automatically after the RUN-ON TIMER).

In addition, the current speed of the drive motor can be displayed with the help of the arrow keys.

Examples of speed indication:

[ \_\_\_\_\_ ] 3690rpm

Speed within control range.

[ ■ \_\_\_\_\_ ] 690rpm

Speed in the lower control range, but minimum speed has not yet been reached.

[ |◀ \_\_\_\_\_ ] 650rpm

Minimum speed reached.

[ \_\_\_\_\_ ▶ | ] 4050rpm

Maximum speed reached.



## 1. DELCOS 3100 electronics LSR

### **SOFT STOP TIME *xxs***

The unit has been switched off and is going to stop after *xx* seconds

### **FAULT: <FAULT MESSAGE>**

Shutdown due to fault

### **WARNING: <WARNING MESSAGE>**

If a warning is present, the status text will appear for 3 seconds

#### **Note**

*For explanations regarding fault and warning messages, see the fault memory table, 1.4.*

### **MAINTENANCE ELAPSED**

If a maintenance interval has elapsed, the status text is not generally overwritten - as is the case with faults - but is displayed additionally every 12 seconds for 3 seconds.

#### **Note**

*For explanations regarding the individual maintenance intervals, see chapter 1.5.*

1.2 Menu structure DELCOS 3100 (examples)



**[MAINTENANCE SCHED.]**

TOTAL RUNNING	12435 h
LOADED HOURS	10987 h
AIR FILTER IN	----- h
OIL FILTER IN	9999 h
SEPARATOR IN	1234 h
OIL CHANGE IN	--- h
MOTOR GREASING	-9999 h
SHUTDOWN	DEACTIVATED

**[CONTROL MENU]**

CUT-OUT POINT	13.0 bar/188 psi
TARGET PRESSURE	12.5 bar/181 psi
AUTOMATIC OPERATION	m <sup>3</sup> /min
DISPLAY UNITS =	ON
REMOTE CONTROL	OFF
TIMER CONTROL	OFF
AUTO RESTART	2 s
POWER LOSS TIME	5 s
START-UP DELAY	0 min
DRYER PRE-RUN	ModBus
RS485- PROTOCOL	19200
RS485-BAUDRATE	1
NUMBER OF SLAVE	

**[FAULT MEMORY]**

12! EXT FAULT	11438 h
2! COMP TEMP	9877 h
4 HIGH TEMP	9476 h
18! EM-STOP	4867 h
6! MOTOR TEMP	4310 h
5! MOTOR TEMP	4310 h
2! SENSOR B2	88 h
10! OVER PRESS	17 h

**[TIMER CONTROL]**

Weekday	Date	Time	
SA	29.01.06	13:55:14	
[SA	01/29/06	13:55:14]	
1	00:00:00:00		
2	00:00:00:00		
3	00:00:00:00		
4	00:00:00:00		
5	00:00:00:00		
6	00:00:00:00		
7	00:00:00:00		
p <sub>1</sub>	00:00:00:00		
p <sub>2</sub>	00:00:00:00		
p <sub>3</sub>	00:00:00:00		
p <sub>4</sub>	00:00:00:00		
p <sub>5</sub>	00:00:00:00		
p <sub>6</sub>	00:00:00:00		
p <sub>7</sub>	00:00:00:00		
p <sub>2</sub> CUT-OUT-POINT	10.0 bar/145 psi		
p <sub>2</sub> TARGET PRESSURE	9.0 bar/130 psi		

**[LIMIT VALUES]**

DESIGN PRESS	13.0 bar/ 188 psi
START PROTECT	0.8 bar/ 11 psi
EXT.LIMIT	3550 rpm
FINAL TEMP WARN	110 °C / 230 °F
FINAL TEMP MAX	120 °C / 248 °F
MIN START TEMP	1 °C / 34 °F
RUN-ON TIME	20 s
SOFT STOP	30 s
VOL.MAX.=	10.0 m3/min
VOL.MIN.=	2.0 m3/min
SOFTWARE:	SD31S1.00

**[OPTIONAL INPUTS]**

OPTION 1	DISCH TEMP
OPTION 2	EXT FAULT
OPTION 3	FREE

**[BASE LOAD SELECT\*]**



OPERATION	ON
CUT-OUT-POINT	13.0 bar/188 psi
TARGET PRESSURE	12.5 bar/181 psi
BASE LOAD COMP.	2
24h K1	K2 K3 K4 K5
CHANGEOVER TIME	24h
QUANT. OF SLAVES	3
QUANT. RESERVE	1
VOL. COMPR. 2 =	20.0 m <sup>3</sup> /min
VOL. COMPR. 3 =	15.0 m <sup>3</sup> /min
VOL. COMPR. 4 =	15.0 m <sup>3</sup> /min
VOL. COMPR. 5 =	8.0 m <sup>3</sup> /min
SWITCH OFF DELAY	30s
START DELAY	5s
LOAD NET IN	15min
NET VOLUME	20m <sup>3</sup>

\*Option

## Re 1.2 Menu structure DELCOS 3100

Menu guidance is provided in the 2nd line of the clear text field.

In order to enter the individual menus press the  key.

You can move between the individual menu branches by using the  (left) and  (right) keys.

By using the  (up) and  (down) keys you can call up parameters within the individual menu branches.

The menus cannot be scrolled horizontally or vertically, i.e. they are limited.

Before changing any parameter, the input of a code may be required, see chapter 1.2.8.





Two minutes after the last key operation, the menu is quit automatically.

The values shown in the menus below and in the overview on page 10 are merely examples!

### **Danger**

*When parameters are changed in the stand-by mode, the unit can start up at any time.*

### 1.2.1 Menu [MAINTENANCE SCHED.]

Move to the menu point [MAINTENANCE SCHED.] using the keys  and . Here, you can call up the individual parameters with the keys  and .

The following parameter inputs are saved under the menu heading [MAINTENANCE SCHED.], and the following values could be displayed:





TOTAL RUNNING	12435 h
LOADED HOURS	10987 h
AIR FILTER IN	----- h
OIL FILTER IN	9999 h
SEPARATOR IN	1234 h
OIL CHANGE IN	--- h
MOTOR GREASING	- 9999 h
SHUTDOWN	DEACTIVATED

#### Note

*For further information, see chapter 1.5 Maintenance intervals.*

Two minutes after the last key operation, the menu is quit automatically.

### 1.2.2 Menu [CONTROL MENU]

Move to the [CONTROL MENU] using keys  and . Here, you can call up the individual parameters with the keys  and .

The following parameter inputs are stored under the menu title [CONTROL MENU], and the following values could be displayed :





CUT-OUT POINT	13.0 bar/188 psi
TARGET PRESSURE	12.5 bar/181 psi
AUTOMATIC OPERATION	
DISPLAY UNITS =	m <sup>3</sup> /min
REMOTE CONTROL	ON
TIMER CONTROL	OFF
AUTO RESTART	OFF
POWER LOSS TIME	2 s
START-UP DELAY	5 s
DRYER PRE-RUN	0 min
RS485- PROTOCOL	ModBus
RS485-BAUDRATE	19200
NUMBER OF SLAVE	1

#### Note

*For further information, see chapter 1.6 Operating modes.*

Two minutes after the last key operation, the menu is quit automatically.

### 1.2.3 Menu [FAULT MEMORY]

Move to the [FAULT MEMORY] menu using keys  and . Here, you can call up the individual entries with the keys  and .

Fault messages are stored in the [FAULT MEMORY] as follows:

12! EXT FAULT	11438 h
2! COMP TEMP	9877 h
4 HIGH TEMP	9476 h
18! EM-STOP	4867 h
6! MOTOR TEMP	4310 h
5! MOTOR TEMP	4310 h
2! SENSOR B2	88 h
10! OVER PRESS	17 h

Shutdowns (faults) are identified with an "!", whereas for warnings the "!" is not displayed.

#### Note

*For further information, see chapter 1.3.12 FAULT MEMORY.*

Two minutes after the last key operation, the menu is quit automatically.

### 1.2.4 Menu [LIMIT VALUES]

Move to the menu [LIMIT VALUES] using keys **←** and **→**. Here, you can call up the individual parameters with the keys **↑** and **↓**.

The following parameter inputs are, for example, stored under the menu heading [LIMIT VALUES]:

DESIGN PRESS	13.0 bar/ 188 psi
START PROTECT	0.8 bar/ 11 psi
EXT.LIMIT	3550 rpm
FINAL TEMP WARN	110 °C / 230 °F
FINAL TEMP MAX	120 °C / 248 °F
MIN START TEMP	1 °C / 34 °F
RUN-ON TIME	90 s
SOFT STOP	30 s
VOL.MAX.=	10.0 m3/min
VOL.MIN.=	2.0 m3/min
SOFTWARE:	SD31S1.00

#### Note

Factory-set limit values cannot be changed by the operator (see also chapter 1.2.8).

Two minutes after the last key operation, the menu is quit automatically.

### 1.2.5 Menu [OPTIONAL INPUTS]

The menu heading [OPTIONAL INPUTS] is provided in the form of optional software. You can have the individual additional monitoring features optionally installed.

Move to the [OPTIONAL INPUTS] menu using keys **←** and **→**. Here, you can allocate three reserve inputs. You simply have to state, which monitoring function has been assigned to which input. Inputs, which are identified as [FREE], are not activated/monitored.

You can call up the individual parameters using keys **↑** and **↓**.

One allocation from the following list can be selected for each input:

Selection	Criterion applied
BEKOMAT FAULT	Fault
BEKOMAT WARN	Warning
DRYER FAULT	Fault
DRYER WARNING	Warning
EXT. WARNING	Warning
EXT. RPM LIMIT	see also chapter 1.6.3
MOT. LUB. SYSTEM	Warning
DISCH TEMP	Warning
EXT. FAULT	Fault
OPERATE_B1	Input connected in series to the pressure sensor
FREE	No action
OIL TEMP	Warning
OIL LEVEL	Warning
OIL PRESS	Fault

Example:

Input 1:	DISCH TEMP
Input 2:	EXT FAULT
Input 3:	FREE

Two minutes after the last key operation, the menu is quit automatically.

### 1.2.6 Menu [TIMER CONTROL]

#### **Danger**

*During programming in the stand-by mode, the machine can start up at any time.*

The real-time clock allows you to switch the control on and off via the timer. Moreover, you can pre-select a change-over of pressure for certain times (e.g. night time reduction). The change-over of pressure is also active, when timer control is not requested [TIMER CONTROL OFF].

If the unit is to be switched on and off via the timer control, you have to activate [TIMER CONTROL ON] in the [CONTROL MENU] and put the unit into operation (switch on).

In order to set the timer or the pressure change-over, move to the menu item [TIMER] using the keys **←** and **→**. Here, you can select/deactivate the individual parameters with the help of keys **↑** and **↓**.

#### Basic clock setting:

Example: [SA 29.01.06 13:55:14] /  
[SA 01/29/06 13:55:14]

- Press key **↻**, the day of the week [SA] flashes
- Re-set the day of the week using the keys **↑** and **↓**
- Acknowledge the new setting by pressing key **↵**
- Now the date flashes [29]
- Re-set the date using keys **↑** and **↓**
- Acknowledge the new setting by pressing key **↵**

The steps described above are the same for setting the month, year, hours, minutes, and seconds. When you acknowledge the new seconds setting with key **↵**, the clock starts to run with this new setting.

The clock setting procedure can be interrupted at any time by pressing the **⏻** key.

# 1. DELCOS 3100 electronics LSR

## Setting of the clock timer:

There are 7 clock timer blocks available.

**Example:** Block No.2, not activated

[2\_\_\_\_\_ 00:00 00:00]

**Example:** Block No.1,

Unit ON from Monday to Friday - daily from  
07:30 to 16:15 h

[1\_MTWTF\_ 07:30 16:15]

After having selected a timer clock block using keys **↑** and **↓**,

**Example:** [1\_\_\_\_\_ 00:00 00:00]

- press key **↻**, the day of the week will flash (Sunday), [1S\_\_\_\_\_ 00:00 00:00]
- select the required setting using keys **↑** and **↓**,
- acknowledge the new setting by pressing key **↻**.
- Then, the next day of the week will flash (Monday),
- Select the required setting using keys **↑** and **↓**,
- acknowledge the new setting by pressing the key **↻**

Repeat the procedure above for the other days of the week and the required times for switching ON and OFF.

The setting procedure of a timer clock can be interrupted at any time by pressing key **⊘**. The previous setting will then be restored.

### Example 1:

With a working time from:

Sunday 22:00 to Saturday 14:00 h,

with a break - daily - from:

12:00 to 12:30 h

the setting of the clock timer should be as follows:

[1S\_\_\_\_\_ 22:00 24:00]

[2\_MTWTF\_ 00:00 12:00]

[3\_MTWTF\_ 12:30 24:00]

[4\_\_\_\_\_S 12:30 14:00]

[5\_\_\_\_\_ 00:00 00:00]

[6\_\_\_\_\_ 00:00 00:00]

[7\_\_\_\_\_ 00:00 00:00]

## Example 2:

From:

Monday 6:00 h to Friday 22:00 h

you require a continuous compressed air supply:

[1\_M\_\_\_\_\_ 06:00 24:00]

[2\_\_TWT\_\_ 00:00 24:00]

[3\_\_\_\_\_F\_\_ 00:00 22:00]

[4\_\_\_\_\_ 00:00 00:00]

[5\_\_\_\_\_ 00:00 00:00]

[6\_\_\_\_\_ 00:00 00:00]

[7\_\_\_\_\_ 00:00 00:00]

## Setting of the pressure change-over

7 further timer blocks are available for switching over to a second pressure range. These are identified by symbol **p<sub>2</sub>**.

These timer blocks can be used for determining, during which period of time the system is to be changed over to the second pressure value. The change-over to the second pressure range is effective for the current values of CUT-OUT POINT and TARGET PRESSURE

The current values of CUT-OUT POINT and TARGET PRESSURE depend on the setting of the base load selection circuit (menu [BASE LOAD SELECT]):

Timer block <b>p<sub>2</sub>1.. p<sub>2</sub>7</b>	Menu [BASE LOAD SELECT] [OPERATION OFF]
Not active	The speed-controlled compressor operates within the pressure range set in the menu [CONTROL]
Active	The speed-controlled compressor operates within the second pressure range set in the menu [TIMER]

Timer block <b>p<sub>2</sub>1.. p<sub>2</sub>7</b>	Menu [BASE LOAD SELECT] [OPERATION ON]
Not active	All of the compressors connected to the base load selection circuit operate within the pressure range set in the menu [BASE LOAD SELECT].
Active	All of the compressors connected to the base load selection circuit operate within the second pressure range set in the menu [TIMER].

Timer block active means:

The system time is within the time range programmed in the timer block.

During the pressure changeover the values for

[ CUT-OUT POINT ] and [ TARGET PRESSURE ]

are displayed unchanged in the menu [CONTROL].

The times of the pressure changeover are adjusted in analogy to the timer setting.

When a timer block of pressure changeover is active, the symbol  $p_2$  flashes in the upper line before the indication of the current line pressure.

**Note**

*The pressure changeover feature can also be activated via an external, potential-free contact.*

If no pressure changeover is requested, deactivate all timer blocks of the pressure changeover feature.

Two minutes after the last key operation, the menu is quit automatically.

### 1.2.7 Changing of values

**Danger**

*During programming in the stand-by mode, the machine can start up at any time.*

If the code (see chapter 1.2.8) is unlocked, any value, except the [LIMIT VALUES] can be changed at any time without the code inquiry.

Move to the value to be changed using keys  $\leftarrow$  and  $\rightarrow$ . Now press key  $\updownarrow$  in order to change to the input mode. If the code has not yet been unlocked, the code inquiry will appear. When the input mode is activated, the value will flash.

**Note**

*In the input mode, keys  $\leftarrow$  and  $\rightarrow$  are inactive.*

After having entered the new value with the keys  $\updownarrow$  and  $\downarrow$ , this new value must be acknowledged by pressing key  $\rightarrow$ . The display stops flashing, and a new menu item can be selected.

In the input mode, you can restore the original setting and at the same time exit the input mode by pressing key  $\ominus$ .

### 1.2.8 Locking/unlocking of the code

In order to avoid unauthorized programming, the settings can be protected by means of a code. The limit values, which are set in the factory, cannot be changed by the operator.

#### Locking

If the code is to be locked, press key  $\odot$ . Then, the following message appears:

"CODE: UNLOCK" (for 1 second)  
 "CODE INPUT: 0000" (value is flashing)

If CODE: [3031] is entered, the following message will appear:

"CODE: LOCK" (for 1 second).

With a wrong code input, the following message will appear:

"CODE: UNLOCK" (for 1 second)

The program then automatically returns to the starting point.

#### Unlocking

The code can be unlocked again by:

- pressing key  $\odot$  or
- pressing key  $\updownarrow$  and by trying to change a protected value.

The code inquiry will then appear:

"CODE: LOCK" (for 1 second)  
 "CODE INPUT: 0000" (value is flashing)

Here, you have to enter CODE: [3031].

If the code input is correct, the following message appears:

"CODE: UNLOCK" (for 1 second)

If the input was incorrect, the following message appears:

"CODE: LOCK" (for 1 second)

The program then automatically returns to the starting point.

**Note**

*The code is not locked automatically; the operator can decide whether to implement this function or not.*

### 1.2.9 Setup code

SETUP - DELCOS 3100			
Code 1 .	0001	A. no.	12345678
Code 2 :	0001	Fab. no.	123456/1234
Code 3 :	0001	RA/XY/291194/CSD3-V01	
COMPAIR Drucklufttechnik			

Label: Setup codes

#### Note

*The setup codes are to be found in the switch cabinet.*

In the case of a failure of the DELCOS 3100 electronics or after their replacement, the control inquires three "setup codes".

The clear text field shows:

```
CompAir
SETUP-CODE 1: _ _ _ _
```

Now, press keys **↑** and **↓** and enter the correct code. Acknowledge the input by pressing key **↵**. Code 2 will then appear automatically. Proceed as with code 1. When code 2 has been acknowledged by pressing key **↵**, code 3 will appear automatically. Proceed also here as with code 1 and code 2.

In the case of an incorrect code input, the system automatically enquires code 1 again, i.e. you have to enter all codes once again.

If you have entered all codes correctly, the machine is reset automatically to the basic setting.

#### Important

**Before the next start-up, it is vital that you check the complete settings of the DELCOS 3100 and restore the individual settings !**

**Especially in the [OPTIONAL INPUTS] menu, the optionally connected monitors have to be re-defined on the basis of the electric circuit diagram, otherwise the monitoring functions will not be available. (See chapter 1.2.5.).**

## 1.3 Commissioning

### Danger

**When the system is in the stand-by operating mode, i.e. LED a flashes, the compressor can start up automatically at any time !**

### 1.3.1 Starting of the unit

When the power supply is switched on, an LED test is run that must be acknowledged by pressing key **↵** before the machine starts up. Prior to setting the unit into operation by pressing the **▶**-key, faults must have been rectified and acknowledged.

The compressor cannot be started at temperatures below the permissible start temperature (see chapter 1.2.4. [LIMIT VALUES]).

If the compressed air mains does not report a requirement at the time of start-up, the unit will go into the stand-by mode - LED a flashes. The clear text field shows [WARNING START WITH] together with the corresponding message (see chapter 1.1.5 STATUS DISPLAY).

Moreover, a safety circuit (start-protection) prevents the drive motor from starting against an internal residual pressure. In this case, the compressor also goes into the stand-by mode. The compressor starts automatically, when the pressure falls below the factory-pre-set start-protection value or when the compressed air mains signals a requirement.

If the optional integrated dryer is provided in the compressor, the dryer pre-run time must be programmed to a value > 0 min in the [CONTROL] menu. The minimum pre-run time can be found in the operating instructions of the integrated dryer.

The compressor is initially switched to stand-by operation. It starts up automatically when the dryer pre-run time has elapsed.

A start-up request, which is activated by pressing the **▶**-key or with a switch-on impulse from the remote control, checks whether the enable conditions for the motor are fulfilled.

If one of the following start-up conditions are not met:

- Final compression pressure below the start-up protection value
- No line pressure requirement reported (only in the automatic operating mode)
- Enable signal from the timer (only with TIMER CONTROL ON)
- Dryer pre-run time elapsed (for further information, see chapter „Integrated dryer“ in the operating instructions of the compressor unit) \*

the unit change over to the stand-by mode for the time being (ON-key flashes).

\* ) OPTION

### 1.3.2 Regulation

The speed is controlled with the help of a PI controller that is implemented in the software and adjusts the speed according to the demand for compressed air. The controller tries to keep the line pressure at the value of the TARGET PRESSURE selected in menu [CONTROL].

As the line pressure increases, the max. permissible speed is continuously computed in order not to exceed the max. permissible motor power.

The maximum speed at a line pressure of, for example, 5 bar will be higher than at a line pressure of 10 bar.

### 1.3.3 Operation under load/idle running

#### **Danger**

*When the unit is in the stand-by mode, i.e. LED a flashes, the compressor can start up automatically at any time !*

When the unit is in the stand-by mode (motor off and the display shows "WARNING START WITH... PRESSURE REQUIREMENT") it starts, when the line pressure is  $\leq$  TARGET PRESSURE.

The operating mode is factory-set to automatic mode. That means: The compressor will deliver compressed air in dependence upon the demand and is shut down automatically (stand-by).

If your compressed air mains has a low or even no consumption at all for a certain period of time, the unit automatically changes over to the off-load mode.

When the pressure falls below the setpoint pressure during the run-on time of the motor, the unit changes again to the on-load mode. The remaining [RUN-ON TIME] is indicated in the clear text field.

When the running-on phase (idle running in the automatic operating mode) is over, the motor is switched off after the pre-selected running-on time and the compressor changes to the stand-by mode.

### 1.3.4 Stopping of the unit

The pressing of the  -key is followed by a [SOFT STOP] of 30 seconds before the motor switches off.

### 1.3.5 Malfunction/shutdowns/power failures

In order to protect the unit, all recognized faults will result in the immediate shutdown of the system or will prevent a start-up.

These faults are displayed in the clear text field and LED h lights up. The messages are transferred to the fault memory and then signalled to the collective fault relay.

The faults have to be acknowledged (after rectification of the fault) by pressing key .

In the case of [POWER LOSS], the LED test appears as soon as voltage is again applied. This must be acknowledged at the unit by pressing key . However, in the remote control operating mode, a new REMOTE ON impulse will be sufficient to signal the acknowledgement to the [FAULT MEMORY].

### 1.3.6 Warning

Warning messages will be signalled via LED g (at the same time, the nature of the warning is indicated in the clear text field). They will not result in the shutdown of the compressor but will be transferred to the fault memory.

Ignoring warnings can result in malfunction.

### 1.3.7 Maintenance

Maintenance messages are signalled by LED f, but will not lead to a shutdown of the compressor and are also not entered into the fault log.

When a maintenance interval has elapsed, i.e. has reached 0 h (hours), the clear text field displays the message [MAINTENANCE ELAPSED]. The elapsed maintenance interval can be determined in the [MAINTENANCE SCHED.] (see 1.2.1.).

Ignoring maintenance intervals can result in malfunction (see chapter 1.5 Maintenance intervals).

### 1.3.8 Collective fault relay

A potential-free contact in the control (see electrical circuit diagram) reports malfunction of the unit.

The contact of the collective fault relay must not be loaded with more than 250 V/1 A.

### 1.3.9 Motor on

A potential free contact of the control (see electrical circuit diagram) signals that the motor is running.

The contact may be loaded with max. 230V/4A.

### 1.3.10 Operating

A potential-free contact of the control (see electrical circuit diagram) signals that the compressor is running (i.e. DELCOS 3100 active).

The contact of the relay may be loaded with up to max. 250 V/1 A.

### 1.3.11 Operating/load hours counter

The operating and load hours of the unit can be called up at any time.

For this, go to the [MAINTENANCE SCHED.] menu and, from there to the menu item [TOTAL RUNNING] or [LOADED HOURS] (see chapter 1.2.1.), where you can read the current status.

### 1.3.12 Fault memory

The fault memory includes the number, fault/warning text and the total hours count at the time when the fault/warning has occurred.

You can call further information about the state of the compressor at the time when a fault is present (so-called extended fault log).

For this, go to the [FAULT MEMORY] menu as described in chapter 1.2.3.

With faults/warnings, which have not been acknowledged, the number of the current fault/warning flashes.

Faults, i.e. shutdowns, are generally identified with an "!", whereas for warnings this "!" is not displayed.



## 1. DELCOS 3100 electronics LSR

### Example:

E.g.: 12! MOTOR TEMP 12345 h.

Explanation:

- 12! means: The same fault "!" has occurred 12 times
- MOTOR TEMP The fault refers to the motor temperature
- 12345 h The fault occurred after 12345 operating hours

The display contains only the 8 latest messages, with the newest entry being on top of the list.

Older entries, which cannot be displayed with regard to the restricted fault memory indication space of 8 entries, are stored in the long-term memory with their corresponding number.

This means: When a fault/warning re-occurs, the relevant fault/warning message appears together with the current number of the fault/warning event and with the hour, in which the fault/warning has re-occurred.

To be able to utilize the extended fault log, proceed as follows:

1. Call the fault to be examined in the menu [FAULT]
2. By pressing key  repeatedly, you can call up the states of the compressors at the time when the fault occurred in subsequent order:
  - Date and time
  - Status of the compressor (e.g. on load)
  - Speed
  - Final compression temperature, final compression pressure and line pressure.

Since this information is shown in line 1 of the clear text field it flashes to underline that these values do not correspond to the current state of the compressor.

### 1.4 Fault table DELCOS 3100 in the case of a fault or warning

#### 1.4.1 Check list

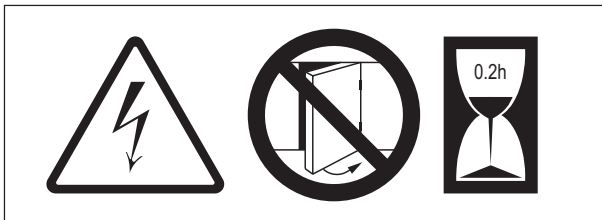

**Attention:** Risk of electroshock due to charged capacitors!

Always disconnect the system from the power supply and wait for 12 minutes before touching electrical components.

This time is required by the power capacitors for discharging!

Generally, loosened connections and plug-in connectors, defective power supplies or the non-observance of installation instructions result in a variety of faults. The fault messages displayed can therefore often be traced back to different causes.

For this reason, please always observe the following check list:

1. The supply voltage to the unit must always be within the permissible limits.
2. If required, the control power transformer must be adjusted to suit local nominal voltages (see electric circuit diagram).
3. The switch cabinet temperature must not exceed 55°C.
4. Without a coupling relay, the line length of retrofitted remote controls (remote on/off) must not exceed 20 m from the switch cabinet.
5. During commissioning and when carrying out maintenance work, check that all terminal screws are tightened and all connectors fit properly.
6. The power supply cabling must have a sufficient cross-section. Therefore, the installation requirements, the line length and the expected conductor temperatures must be taken into account when selecting the cable(s).
7. When retrofitting switch equipment, the power control transformers must not be "tapped" under any circumstances, since this can result in overloading.
8. Always use CompAir spare parts.
9. Never connect additional switch or measuring equipment without CompAir's prior permission.
10. Never relocate measuring transducers away from the unit.
11. In the case of queries, please have the following information on hand so that we can provide quick and specific support:
  - Type of unit / serial no.
  - Order no.
  - Circuit diagram for drawing no. and Id no.
  - Information regarding the operating conditions of the unit
  - Information regarding the accessories retrofitted by yourselves (remote controls, etc.)
  - Other subsequent modifications or attachments to the unit
  - The exact description of the fault

#### 1.4.2 Table of faults/warnings

On the following pages you will find the fault table DELCOS 3100 with possible causes and remedies

1. DELCOS 3100 electronics LSR

<b>[DISPLAY] / Problem</b>	<b>Possible cause</b>	<b>Remedy</b>
[FAULT POWER LOSS]	Power failure Voltage drop Cabling defective Terminals loose/loosened	Search for cause Search for cause Check, if required, repair Check all connecting terminals and
[FAULT EM-STOP]	Emergency stop is/was activated Emergency stop switch defective Cabling defective	Unlock Check, if required, replace Check, if required, repair
[FAULT EM-STOP (SR)]	No emergency stop recognition of the SR electronics Emergency stop switch defective Cabling defective	Check, if required, replace Check, if required, replace
[FAULT MOTOR TEMP]	Motor has been started too frequently Insufficient motor cooling Excessive power requirement Defective power supply Motor defective	Limit the number of starts per hour Improve Check, search for cause Check, search for cause Check, if required, replace
[FAULT COMP TEMP]	Final compression temperature exceeded <sup>(1)</sup>	-
[WARNING HIGH TEMP]	Intake temperature too high Insufficient cooling Unit is being operated with open access panels Water injection quantity/temperature insufficient/excessive Oil injection quantity/temperature Wrong type of oil/viscosity Temperature sensor R2 defective (Temperature display too high)	Improve Improve Close access panels Check, search for cause Check, search for cause Check, if required, replace oil Check, if required, replace
[FAULT START TEMP]	Starting attempted at too low temperature <sup>(1)</sup> Temperature sensor R2 defective (Temperature display too low)	Heat compressor room Check, if required, replace
[WARNING HIGH PRESS]	Operating pressure exceeded by 1.0 bar/14 psi <sup>(1)</sup>	-
[FAULT OVER PRESS ]	Operating pressure exceeded by 1.5 bar/21 psi <sup>(1)</sup> Excessive pressure losses in the unit Mains pressure switching points <sup>(4)</sup> too high External pressure requirement too high Pressure sensor B1 or B2 defective (wrong display)	Check, search for cause Correct Check remote on-load/off-load Check, if required, replace
[FAULT SENSOR B1 ]	Mains pressure sensor defective	-
[FAULT SENSOR B2 ]	Final compression pressure sensor defective	-
[FAULT SENSOR R2 ]	Final compression temperature sensor defective Pressure or temperature sensor defective Cabling to the sensor defective	Check, if required, replace Check, if required, repair
[FAULT DIRECT ROT]	Wrong direction of rotation of the drive motor (see electrical circuit diagram)	Connect the phase sequence correctly
[FAULT MAINT PER]	Shutdown maintenance <sup>(2)</sup> activated and Maintenance interval elapsed by 100 hours <sup>(2)</sup>	Carry out maintenance and re-program interval newly
[FAULT SOLENOID]	Short-circuit or cable break Solenoid valve Y1 or Y4	Check, if required, repair or replace
[FAULT CONVERTER]	Communication of DELCOS 3100 with the SR drive via CAN interface failed.	Check - Control voltages of the SR system - Fuses of the SR system - Wiring of the CAN interface - If no fault can be found, inform CompAir service technician.

1. DELCOS 3100 electronics LSR

<b>[DISPLAY] / Problem</b>	<b>Possible cause</b>	<b>Remedy</b>
[FAULT COOLING]	Air-cooled units: Failure of the unit's fan Excessive resistance through intake/exhaust channels Wrong setting of the fan motor protective switch Fan motor defective Water-cooled units: Insufficient cooling water supply Cooling water temperature too high Cooling water flow insufficient Filter clogged Cooling water solenoid valve does not open Air in the system	Check, if required install auxiliary fan Set to 110% of the nominal fan flow Check, if required, replace Improve Increase Clean Check, if required, replace Bleed
[FAULT SPEED LOW]	Speed below permitted minimum value. Faulty connection from emergency stop to SR system.	Inform CompAir service technician. Check connection of emergency stop on gate board plug J19.
[WARNING: MS BUS:A02] (OPTION)	Module failed in operating mode	Check power supply to the module. Check fuse in the module.
[WARNING: MS BUS:A06] (OPTION)	Module failed in operating mode	Check power supply to the module. Check fuse in the module.
[WARNING: MS-BUS A12] (OPTION)	Relay module for ZLT failed.	Check power supply to the module. Check fuse in the module.
[FAULT EXT FAULT] (OPTION)	Shutdown due to external fault (monitored via input: EXT FAULT <sup>(3)</sup> )	Check, search for cause
[BEKOMAT FAULT] (OPTION)	Connected condensate drain valve (Bekomat) defective.	Check, search for cause
[BEKOMAT WARN] (OPTION)	Connected condensate drain valve (Bekomat) defective.	Check, search for cause
[DRYER WARNING] (OPTION)	Fault of the integrated dryer.	See chapter "Integrated dryer" in the operating instructions of the compressor
[DRYER FAULT] (OPTION)	Fault of the integrated dryer.	See chapter "Integrated dryer" in the operating instructions of the compressor
[Warnung: EXT. WARN.] (OPTION)	Warning by external device. (Monitored via input: Ext. Warn. (3))	Check, search for cause.
[FAULT DELCOS]	Hardware fault in DELCOS	Replace DELCOS electronics
[WARNING AIR FILTER] (OPTION)	Excessive differential pressure air filter	Check, if required, replace air filter
[WARNING OIL FILTER] (OPTION)	Excessive differential pressure oil filter	Check, if required, replace oil filter
[WARNING OIL TEMP] (OPTION)	Oil injection temperature too high (monitored via input: OIL TEMP <sup>(3)</sup> )	Check, search for cause
[WARNING SEPARATOR] (OPTION)	Excessive differential pressure fine separator	Check, if required, replace fine separator
[FAULT OIL PRESS] (OPTION)	No/insufficient oil pressure (monitored via input: OIL PRESS <sup>(3)</sup> )	Check, search for cause
[WARNING OIL LEVEL] (OPTION)	Oil level too low (monitored via input: OIL LEVEL <sup>(3)</sup> )	Check, if required, top up oil

1. DELCOS 3100 electronics LSR

<b>[DISPLAY] / Problem</b>	<b>Possible cause</b>	<b>Remedy</b>
[WARNING OIL FILTER]	Excessive differential pressure oil filter	Check, if required, replace oil filter
[WARNING DISCH TEMP] (OPTION)	Excessive compressed air discharge temperature (monitored via input: DISCH TEMP <sup>(3)</sup> )	Check, search for cause
[WARNING: MOT.LUB. SYST.] (OPTION)	Fault in the motor lubricating system or LC unit running short.	See chapter "motor lubricating system" in the operating instructions of the compressor system.
[WARNING BATTERY]	The battery of the real-time clock is exhausted	Replace the real-time clock module
[WARNING: INPUT 1] [WARNING: INPUT 2] [WARNING: INPUT 3]	One of reserve inputs 1..3 was controlled, but is programmed as [FREE].	Check according to the input assignment. <sup>(3)</sup>
[FAULT: POWER LOSS 20V]	20V supply of control transformer failed.	Check control transformer and fuses.
[* Wrong SR-Serial Number] [SETUP-CODE 1: _____? ]	The serial number of the SR drive saved in DELCOS 3100 is not identical with the serial number read out from the SR drive. The electronic printed circuit diagrams of the SR drive may have been changed.	Re-enter setup code
[*** Wrong SR-Mode ***] [SETUP-CODE 1: _____? ]	The mode of the SR drive saved in DELCOS 3100 is not identical with the mode read out from the SR drive. The electronic printed circuit diagrams of the SR drive may have been changed.	Re-enter setup code
[COMPAIR] [SETUP-CODE 1: ____?]	Hardware fault in DELCOS	DELCO electronics has to be replaced; stopgap measure: Enter setup codes, check all settings and, if required, re-set <sup>(2)(3)(4)(5)</sup>
A fault/warning cannot be acknowledged	The fault/warning is still present	Search for cause and rectify
No display	- No voltage to the machine - DELCOS control voltage (10 VAC) not applied	Fix power supply, check fuses Check fuses, if required, replace
Pressure and temperature display failed, Display (----)	- DELCOS control voltage (20 VAC) not applied	Check fuses, if required, replace
Unit does not restart automatically after power failure	- Function "Automatic restart" not ctivated - Power failure lasted too long <sup>(4)</sup>	Switch on <sup>(4)</sup>
Unit is permanently running in the idle mode without changing automatically over to the stand-by mode	- Operating mode [CONTINUOUS OPERATION] selected <sup>(4)</sup> - Very short pressure requirements during the running-on phase	Select [AUTOMATIC OPERATION]
No compressed air supply within the set points <sup>(4)</sup>	- Pressure changeover by timer or external contact active <sup>(5)</sup>	-

1. DELCOS 3100 electronics LSR

<b>[DISPLAY] / Problem</b>	<b>Possible cause</b>	<b>Remedy</b>
[FAULT: SR-DRIVE ( 1)] +15V control board supply over-voltage	Incorrect primary voltage setting on mains transformer. Low mains supply voltage. Ribbon cable/connectors linking control PCB (PCB94) and gate drive PCB (PCB95) poorly connected or defective. Faulty or damaged rotor position sensor cable/wiring. Control or gate drive PCB defect.	Check the mains supply voltage (of all phases) is within the expected range for the installation. Check the appropriate transformer tapping has been set (using the terminals adjacent to the control panel transformer). Check ribbon cable/connectors linking the control PCB94 J13 and gate drive PCB95 J17. Check condition of the rotor sensor cable and its connections to the control PCB (PCB94) J1. Otherwise contact CompAir Service.
[FAULT: SR-DRIVE ( 2)] +15V control board supply under-voltage		
[FAULT: SR-DRIVE ( 3)] User +15V control board supply over-voltage	Wiring error or fault on control PCB connector J5. Control or gate drive PCB defect.	Check status of connections at control PCB (PCB94) J5 (normally J5 pin 3 should not be connected). Otherwise contact CompAir Service.
[FAULT: SR-DRIVE ( 4)] User +15V control board supply under-voltage		
[FAULT: SR-DRIVE ( 5)] -15V control board supply over-voltage	Ribbon cable/connectors linking control PCB (PCB94) & gate drive PCB (PCB95) poorly connected or faulty. Control or gate drive PCB defect.	Check ribbon cable/connectors linking the control PCB94 J13 and gate drive PCB95 J17. Otherwise Contact CompAir Service.
[FAULT: SR-DRIVE ( 6)] -15V control board supply under-voltage		
[FAULT: SR-DRIVE ( 7)] User -15V control board supply over-voltage		
[FAULT: SR-DRIVE ( 8)] User -15V control board supply under-voltage		
[FAULT: SR-DRIVE ( 9)] +15V current sensor supply over-voltage	Current sensor wiring or connector defect. Current sensor failure. Control or gate drive PCB defect.	Check integrity of wiring and connectors from control PCB (PCB94) connector J10 to current sensor. Otherwise contact CompAir Service.
[FAULT: SR-DRIVE (10)] +15V current sensor supply under-voltage		
[FAULT: SR-DRIVE (11)] -15V current sensor supply over-voltage		
[FAULT: SR-DRIVE (12)] -15V current sensor supply under-voltage		
[FAULT: SR-DRIVE (13)] +24V control supply over-voltage	Defective or damaged wiring in emergency stop loop to control PCB (PCB94). Ribbon cable/connectors linking control PCB (PCB94) & gate drive PCB (PCB95) poorly connected or faulty. Control or gate drive PCB defect.	Check emergency stop circuit from J5 pin 4 via e-stop switch back to J3 pin 9 (connectors on control PCB94). Check ribbon cable/connectors linking the control PCB94 J13 and gate drive PCB95 J17. Otherwise contact CompAir Service.
[FAULT: SR-DRIVE (14)] +24V control supply under-voltage		

1. DELCOS 3100 electronics LSR

<b>[DISPLAY] / Problem</b>	<b>Possible cause</b>	<b>Remedy</b>
[FAULT: SR-DRIVE (15)] Motor phase over-current	Incorrect motor connections or damaged motor cable. Motor insulation failure. Current sensor connector or wiring failure. Current sensor defective. Control or gate drive PCB defect.	Check connections of motor to power converter are correct. Inspect motor cables for damage. Check condition of cabling and connectors between current sensor and control PCB (PCB94). Otherwise contact CompAir Service.
[FAULT: SR-DRIVE (16)] Phase B over-current	Not applicable to this application – a single current sensor is used, connected to “Phase A” current control channel. Presence of these faults indicates a control or gate drive PCB defect.	Contact CompAir Service.
[FAULT: SR-DRIVE (17)] Phase C over-current		
[FAULT: SR-DRIVE (18)] Negative current fault	Incorrect routing of motor cable through current sensor. Motor connection error. Current sensor incorrectly connected to control PCB, or disconnected from control PCB. Current sensor faulty or current sensor wiring defective. Control or gate drive PCB defect. Motor insulation failure.	Check motor cables are correctly connected and are properly routed through the current sensor. Check cable and connectors from control PCB (PCB94) connector J10 to current sensor. Where the control PCB (PCB94) has multiple current sensor sockets within J10, check sensor is plugged into the correct Phase A socket (and NOT “B”, “C” or “Brake”). Otherwise contact CompAir Service.
[FAULT: SR-DRIVE (19)] DC link over-voltage	Excessive AC input supply (mains) voltage. Motor insulation failure. Control or gate drive PCB defect.	Check all AC line-to-line voltages are <506V AC. Otherwise contact CompAir Service.
[FAULT: SR-DRIVE (20)] System mode setting	Software parameter programming or set-up error.	Contact CompAir Service.
[FAULT: SR-DRIVE (21)] DC link capacitor voltage imbalance	Electrolytic capacitor failure or balance resistor defect. Control or gate drive PCB defect. Ribbon cable/connectors linking control PCB (PCB94) and gate drive PCB (PCB95) missing or defective. High voltage wiring fault.	Check ribbon cable/connectors linking the control PCB94 J13 and gate drive PCB95 J17. Otherwise contact CompAir Service.
[FAULT: SR-DRIVE (22)] DC link measurement connector Interlock	Interlock between gate drive PCB J8 pins 1 and 2 open. Ribbon cable/connectors linking control PCB (PCB94) and gate drive PCB (PCB95) missing or defective. Control or gate drive PCB defect.	Check wiring at gate drive PCB J8 (loop between pins 1 & 2). Check ribbon cable/connectors linking the control PCB94 J13 and gate drive PCB95 J17. Otherwise contact CompAir Service.
[FAULT: SR-DRIVE (23)] Safety interlock open without response from Delcos controller.	Open-circuit or defective connections in emergency stop loop to Delcos controller. Faulty emergency stop switch contact or connection.	Check integrity of emergency stop circuit from Delcos pin 22 via emergency stop switch contact, back to Delcos pin 23. Otherwise contact CompAir Service.
[FAULT: SR-DRIVE (24)] FPGA WDT (Altera watchdog timer)	Control board failure.	Contact CompAir Service.
[FAULT: SR-DRIVE (25)] Main contactor	Not applicable to this application – presence of this fault indicates a wiring error, or a defect in the control PCB (PCB94) or gate drive PCB (PCB95).	Check wiring between J11 pins 3 and 6 on the control PCB (PCB94) and J15 pins 4 and 5 at the gate drive PCB (PCB95). Otherwise contact CompAir Service.

1. DELCOS 3100 electronics LSR

<b>[DISPLAY] / Problem</b>	<b>Possible cause</b>	<b>Remedy</b>
[FAULT: SR-DRIVE (26)] Brake resistor over-current	Not applicable to this application – dynamic braking not installed. Presence of this fault indicates a wiring error to the current sensor socket J10 on the control PCB (PCB94) or a defect in the control PCB itself.	Where the control PCB (PCB94) has multiple current sensor sockets within J10, check sensor is plugged into the correct Phase A socket (and NOT “B”, “C” or “Brake”). Otherwise contact CompAir Service.
[FAULT: SR-DRIVE (27)] Control PCB hardware fault latch	Control PCB (PCB94) defect.	Contact CompAir Service.
[FAULT: SR-DRIVE (28)], [FAULT: SR-DRIVE (29)] Missing mains phase or Mains low	One phase of AC mains supply disconnected, or abnormally low in voltage. Ribbon cable/connectors linking control PCB (PCB94) & gate drive PCB (PCB95) poorly connected or faulty. Incorrect phase sequence. Wiring fault to mains supply monitoring circuitry. Defective gate drive (PCB95) or control PCB (PCB94).	Check voltage of each mains phase to earth or neutral. Check external mains supply fuses and isolator(s). Check phase sequence correct at supply connections. Check wiring to gate drive PCB (PCB95) J13, J14. Check ribbon cable/connectors linking the control PCB94 J13 and gate drive PCB95 J17. Otherwise contact CompAir Service.
[FAULT: SR-DRIVE (30)] DC link under-voltage	Rectifier control wiring error or defect. Ribbon cable/connectors linking control PCB (PCB94) & gate drive PCB (PCB95) poorly connected or faulty. Faulty rectifier module(s), faulty gate drive PCB (PCB95) or control PCB (PCB94).	Check wiring and connectors from gate drive PCB (PCB95) J10 to rectifier modules on heatsink. Check ribbon cable/connectors linking the control PCB94 J13 and gate drive PCB95 J17. Otherwise contact CompAir Service.
[FAULT: SR-DRIVE (31)] Phase A motor open-circuit	Motor cable disconnected or damaged. Motor winding open-circuit. Gate drive circuit disconnected (J1 and J2 on PCB95). Defective gate drive (PCB95) or control PCB (PCB94).	Check phase A motor connections and cables. Check Phase A motor winding continuity. Check wiring and connectors at gate drive PCB (PCB95) J1 and J2. Otherwise contact CompAir Service.
[FAULT: SR-DRIVE (32)] Phase B motor open-circuit	Motor cable disconnected or damaged. Motor winding open-circuit. Gate drive circuit disconnected (J3 and J4 on PCB95). Defective gate drive (PCB95) or control PCB (PCB94).	Check phase B motor connections and cables. Check Phase B motor winding continuity. Check wiring and connectors at gate drive PCB (PCB95) J3 and J4. Otherwise contact CompAir Service.
[FAULT: SR-DRIVE (33)] Phase C motor open-circuit	Applicable only for 3-phase motors: Motor cable disconnected or damaged. Motor winding open-circuit. Gate drive circuit disconnected (J5 and J6 on PCB95). Defective gate drive (PCB95) or control PCB (PCB94).	Check phase C motor connections and cables. Check Phase C motor winding continuity. Check wiring and connectors at gate drive PCB (PCB95) J5 and J6. Otherwise contact CompAir Service.

1. DELCOS 3100 electronics LSR

<b>[DISPLAY] / Problem</b>	<b>Possible cause</b>	<b>Remedy</b>
[FAULT: SR-DRIVE (34)] IGBT fault A1	Defective IGBT module or gate drive PCB (PCB95).	Contact CompAir Service.
[FAULT: SR-DRIVE (35)] IGBT fault A2		
[FAULT: SR-DRIVE (36)] IGBT fault B1		
[FAULT: SR-DRIVE (37)] IGBT fault B2		
[FAULT: SR-DRIVE (38)] IGBT fault C1		
[FAULT: SR-DRIVE (39)] IGBT fault C2		
[FAULT: SR-DRIVE (40)] IGBT Fault Brake	Not applicable to this application – presence of this fault indicates a defect in the gate drive or control PCB.	Contact CompAir Service.
[FAULT: SR-DRIVE (41)] RS232 communications	Not applicable to this application – presence of this fault indicates a defect in the control PCB.	Contact CompAir Service.
[FAULT: SR-DRIVE (42)] Rotor sensor supply fault	Rotor sensor connector not plugged in to control PCB. Rotor sensor wiring defect, or faulty sensor on motor. Control PCB (PCB94) defect.	Check rotor sensor is plugged in to control PCB (PCB94) J1. Check rotor sensor cable is not damaged and the integrity of wiring to the connector plug. Otherwise contact CompAir Service.
[FAULT: SR-DRIVE (43)] Rotor sensor fault	Rotor sensor wiring defect. Faulty or damaged sensor on motor. Control PCB (PCB94) defect.	Check condition of the rotor sensor cable and its connections to control PCB (PCB94) J1. Otherwise contact CompAir Service.
[FAULT: SR-DRIVE (44)] Over-speed	Rotor sensor or rotor sensor cable/connection defect. Control PCB (PCB94) defect. Compressor controller defect	Check condition of the rotor sensor cable and its connections to control PCB (PCB94) J1. Otherwise contact CompAir Service.
[FAULT: SR-DRIVE (45)] Heatsink temperature sensor fault	Wiring defect or poor connection between sensor PCB assembly and control PCB J11. Defective temperature sensor on heat sink. Control PCB (PCB94) defect.	Check sensor wiring and connections at J11 (pins 1 and 2) on control PCB (PCB94). Otherwise contact CompAir Service.
[FAULT: SR-DRIVE (46)] Motor temperature sensor fault	Not applicable to this application – motor temperature sensor input is disabled in software. (Motor temperature sensor is instead connected to the Delcos compressor controller.) Presence of this fault indicates a defect in the control PCB.	Contact CompAir Service.



1. DELCOS 3100 electronics LSR

<b>[DISPLAY] / Problem</b>	<b>Possible cause</b>	<b>Remedy</b>
[FAULT: SR-DRIVE (47)] Heatsink temperature too high	Heat sink cooling fan MCB open. Control panel air inlet filters blocked. Prolonged operation at excessive ambient temperature. Wiring to fan motor damaged or faulty. Heat sink cooling fan defective. Control (PCB94) or gate drive PCB (PCB95) defective. Ribbon cable/connectors linking control PCB (PCB94) & gate drive PCB (PCB95) poorly connected or faulty.	Verify that the heat sink cooling fan MCB is closed. Check the condition of the control box air inlet filters. Verify that the ambient temperature is not excessive. Check the wiring to the fan, from the mains transformer and MCB via the gate drive PCB (PCB95). Verify that the connections to the fan control relay (on the gate drive PCB) are OK – J15 pins 4 and 5 on the gate drive PCB. Check ribbon cable/connectors linking the control PCB94 J13 and gate drive PCB95 J17. Check fan motor capacitor connections. Otherwise contact CompAir Service.
[FAULT: SR-DRIVE (48)] Motor temperature too high	Not applicable to this application – motor temperature sensor input is disabled in software. (Motor temperature sensor is instead connected to the Delcos compressor controller.) Presence of this fault indicates a defect in the control PCB (or that a software setting has been tampered with).	Contact CompAir Service.
[FAULT: SR-DRIVE (49)] Current sensor fault	Motor cable not routed through current sensor. Damaged current sensor cable or faulty connections between sensor and control PCB (PCB94). Defective current sensor. Control (PCB94) or gate drive PCB (PCB95) defective.	Verify that the correct motor cables are routed through the current sensor, as indicated inside the controller. Check condition of the current sensor cable and its connectors at the sensor and at the control PCB (PCB95) J10 (ensure cable plugged into “Phase A” socket, where J10 has more than one socket available). Otherwise contact CompAir Service.
[FAULT: SR-DRIVE (50)] Current sensor fault – phase B	Not applicable to this application – a single current sensor is used, connected to “Phase A” current control channel. Presence of these faults indicates a defect in the gate drive or control PCB.	Contact CompAir Service.
[FAULT: SR-DRIVE (51)] Current sensor fault - phase C		
[FAULT: SR-DRIVE (52)] CAN communications failure	Control PCB (PCB94) defect. Ribbon cable/connectors linking control PCB (PCB94) & gate drive PCB (PCB95) poorly connected or faulty. Cable or connector fault in the CAN link between the door-mounted Delcos compressor controller and the motor control PCB (PCB94). Defect in the Delcos compressor controller.	Check ribbon cable/connectors linking the control PCB94 J13 and gate drive PCB95 J17. Check connections and cable linking the control PCB (PCB94) J8 with the Delcos CAN communications module. Otherwise contact CompAir Service.
[FAULT: SR-DRIVE (53)] User enable link open-circuit	Not applicable to this application – presence of this fault indicates a defect in the control PCB.	Contact CompAir Service.

1. DELCOS 3100 electronics LSR

<b>[DISPLAY] / Problem</b>	<b>Possible cause</b>	<b>Remedy</b>
[FAULT: SR-DRIVE (54)] Motor stall	Rotor position sensor misaligned or defective. Mechanical failure of motor or air-end. Gate drive or control PCB defect.	Contact CompAir Service.
[FAULT: SR-DRIVE (55)] Pre-charge fault	Not applicable to this application – presence of this fault indicates a defect in the gate drive or control PCB.	Contact CompAir Service.
[FAULT: SR-LOCKOUT ( 1)] Altera configuration error	Programmable logic device has not been correctly configured at power-up. Possibly caused by extreme electrical interference or power-line noise during the start-up sequence. Otherwise control PCB (PCB94) defect.	Cycle compressor power off and on again – if fault recurs then contact CompAir service.
[FAULT: SR-LOCKOUT ( 2)] Motor control diagnostic keypad lockout	Faulty service/diagnostic keypad attached to the control PCB (PCB94) J2, or keys stuck on this keypad. Improper device connected to J2. Control PCB defect.	Check that nothing is connected to the control PCB J2 (9 way 'D' connector). Cycle compressor power off and on again – if fault recurs then contact CompAir service.
[FAULT: SR-LOCKOUT ( 3)] Restoring default settings	Initialization routine interrupted by power failure or faulty CAN wiring. Delcos compressor controller software error or SR motor control PCB (PCB94) defect.	Check connections and cable linking the control PCB (PCB94) J8 with the Delcos CAN communications module. Cycle compressor power off and on again – if fault recurs then contact CompAir service.
[FAULT: SR-LOCKOUT ( 4)] Safety interlock circuit	Not applicable to this application – presence of this fault indicates a defect in the control PCB.	Cycle compressor power off and on again – if fault recurs then contact CompAir service.
[FAULT: SR-LOCKOUT ( 5)] Setting lockout	Presence of this fault indicates a defect in the control PCB.	Cycle compressor power off and on again – if fault recurs then contact CompAir service.
[FAULT: SR-LOCKOUT ( 6)] Internal fault	Motor control software error. Possibly caused by extreme electrical interference or power-line noise during the start-up sequence. Otherwise control PCB (PCB94) defect.	Cycle compressor power off and on again – if fault recurs then contact CompAir service.
[FAULT: SR-LOCKOUT ( 7)] Contactor open error (jammed or failed in open state)	Not applicable to this application – presence of this fault indicates a wiring error, or a defect in the control PCB (PCB94) or gate drive PCB (PCB95).	Check wiring between J11 pins 3 and 6 on the control PCB (PCB94) and J15 pins 4 and 5 at the gate drive PCB (PCB95). Check ribbon cable/connectors linking the control PCB94 J13 and gate drive PCB95 J17. Cycle compressor power off and on again – if fault recurs then contact CompAir service.
[FAULT: SR-LOCKOUT ( 8)] Contactor closed error (jammed or failed in closed state)	Not applicable to this application – presence of this fault indicates a wiring error, or a defect in the control PCB PCB94) or gate drive PCB (PCB95).	Check wiring between J11 pins 3 and 6 on the control PCB (PCB94) and J15 pins 4 and 5 at the gate drive PCB (PCB95). Check ribbon cable/connectors linking the control PCB94 J13 and gate drive PCB95 J17. Cycle compressor power off and on again – if fault recurs then contact CompAir service.

- (1) Unit-specific setting: See menu 1.2.4 [LIMIT VALUES]
- (2) Individual setting: See menu 1.2.1 [MAINTENANCE SCHED.]
- (3) Individual setting: See menu 1.2.5 [OPTIONAL INPUTS]
- (4) Individual setting: See menu 1.2.2 [CONTROL MENU]
- (5) Individual setting: See menu 1.2.7 [TIMER CONTROL]

## 1.5 Maintenance intervals

### **Danger**

**When the unit is in the stand-by mode, i.e. LED a flashes, the compressor can start up automatically at any time !**

The programming of the maintenance intervals must be tailored to your specific application conditions, since the clogging degree of the air filter depends for example on the intake conditions on site.

In the factory, the setting values for the maintenance intervals are therefore protected in the menu [MAINTENANCE SCHED], the clear text field shows - - - -.

You can set your individual maintenance intervals for air filters, oil filters, fine separators, motor grease and oil change by yourself (see chapter 1.2.7) and therefore replace your maintenance book to some extent. The values for the maintenance intervals can be programmed from 0...9999 hours.

If no monitoring of the maintenance intervals is requested, program a value above 9999 hours. The display shows - - - - , i.e. this/these maintenance interval/s is/are blocked.

When the setting value has counted down to 0 hours, the message [MAINTENANCE ELAPSED] appears in the clear text field, and LED f (Maintenance) flashes simultaneously.

You should carry out the scheduled maintenance now, as improper maintenance can result in malfunctions.

The current count of the maintenance intervals can be read from the [MAINTENANCE SCHED.] menu.

It is possible to display negative, i.e. overdue maintenance intervals.

Moreover, a shutdown can be activated/deactivated for maintenance intervals, if a maintenance interval has counted down to -100 hours. If one of the intervals has reached this shutdown threshold, the shutdown is triggered off by the collective fault LED h, which acts in addition to LED f. The message [FAULT MAINT PER] is present in the fault memory as well as in the clear text field.

After having carried out the maintenance work, re-program the maintenance interval and then acknowledge - for a restart - the [FAULT MAINT PER] by pressing key .

## 1.6 Operating modes

### 1.6.1 Automatic and continuous operation

The selection of [AUTOMATIC OPERATION] or [CONTINUOUS OPERATION] is made under the [CONTROL MENU] (see chapter 1.2./ - Changing of values).

The [AUTOMATIC OPERATION] mode is the most economic, because the control stops the compressor when no compressed air is required and restarts the unit automatically in the case of demand for compressed air.

The operating mode [CONTINUOUS OPERATION] is

required in special applications only. Continuous operation prevents the stopping of the drive motor even if no compressed air is required. The operation is then continued in the idle mode. In contrast to the automatic operation, you can start the unit, although no requirement is present from the compressed air mains.

### 1.6.2 Setting of the flow unit for the status display [DISPLAY UNITS = m<sup>3</sup>/min]

This value can be set to [m<sup>3</sup>/min], [m<sup>3</sup>/h] or [cfm].

The status display shows the flow currently delivered by the machine. Since the number of characters on the LCD display is restricted, the unit shown can be pre-set. This unit is not indicated on the status display.

### 1.6.3 Speed limitation

The maximum revving speed of the machine can be limited.

To this end, one of the inputs must be programmed to the function "EXT. RPM LIMIT" in the menu [OPTIONAL INPUTS].

When the corresponding input is now closed by an external contact, the speed is limited to the value set in menu item "EXT. LIMIT" of the menu [LIMIT VALUE].

It must be noted that this value does not represent a fixed speed, i.e. in the case of a reduced demand in the compressed air network, the machine may adjust the speed also to a value below "EXT. LIMIT".

### 1.6.4 Remote control (remote ON/OFF) Important

**Only potential-free contacts may be connected to the terminal strip. External voltages will result in the destruction of DELCOS 3100.**

**The distance between potential-free contacts and the terminal strip must not exceed 20 metres. If required, install coupling relays in the control cabinet.**

### **Danger**

**In this operating mode, the compressor can start up automatically at any time!**

The control offers the possibility of switching the compressor on or off externally via the connection of a potential-free contact.

To activate the input "remote control ON/OFF" (terminals X3.25/X3.26) you have to select [REMOTE CONTROL ON] in the [CONTROL MENU].

- During [REMOTE CONTROL ON] LED d is on and key **I** and key **O** of the compressor are locked.
- For starting the unit, the control requires a REMOTE ON edge at the Remote ON/OFF input.
- The unit is operating as long as the remote ON/OFF input is closed.
- The unit stops when the remote ON/OFF input is opened.
- When the unit was switched on manually and the operating mode is changed over to [REMOTE CONTROL ON] it remains in operation as long as the remote ON/OFF input is closed.
- When the remote mode is switched off [REMOTE CONTROL OFF], the unit remains switched ON or OFF.

### 1.6.5 Remote control (pressure changeover)

#### Important

**Only potential-free contacts may be connected to the terminal strip. External voltages result in the destruction of DELCOS 3100.**

**The distance between potential-free contacts and the terminal strip must not exceed 20 metres. If required, install coupling relays in the control cabinet.**

#### Danger

***In this operating mode, the compressor can start up automatically at any time !***

The input "second pressure band" (terminals X3.23/ X3.24) can be used for changing over to a second pressure range (see chapter [TIMER CONTROL] menu).

While the pressure is being changed over, the symbol "p2" is flashing before the current line pressure is displayed.

### 1.6.6 Automatic restart after power failure

#### Danger

***In this operating mode, the compressor can start up automatically at any time !***

You can activate or deactivate [AUTO RESTART] in the [CONTROL MENU] (see chapter 1.2.2).

After a power failure, which has not taken longer than approx. 2 seconds, the compressor is automatically restarted, provided that it was switched on before the power failure occurred, i.e. it was in operation or in the stand-by mode.

Failures of a duration of more than 2 seconds trigger off the message [POWER LOSS], and [AUTO RESTART] does not take place.

The menu item [POWER LOSS TIME] (see chapter 1.2.2.) can be programmed to values between 2 to 999 seconds.

In addition, you can program a start delay of 1 to 60 seconds in order to ensure that, with stations comprising several compressors, the compressors do not start simultaneously so that the power supply mains is relieved. The clear text display will then show:

[WARNING START IN xxs].

In the remote control operating mode, remote on signal must still be applied for a restart. In the timer control operating mode, the clock timer enable signal must still be applied.

### 1.6.7 Unlimited automatic restart after power failure

The control can execute an automatic restart after a power failure of any duration.

To this end you have to read the following safety notes and enable the unlimited automatic restart by entering a code.

#### Danger

***In this operating mode, the compressor can start automatically after a power failure of any duration. Read the safety regulations that are valid for your country (e.g. EN1012-1, EN60204) to see whether you are allowed to enable an unlimited automatic restart and which precautions are to be taken for this.***

***In any case, provide warning signs on the compressor, keep the compressor room locked and instruct your personnel accordingly.***

***Install the master switch prescribed in EN60204 and provide the relevant warning signs.***

To enable the unlimited automatic restart, proceed as follows:

1. Press the code key **C**
2. Enter code "8888"
3. Press the key **↵** to confirm the code

After the enable was given, the menu item can be programmed to [POWER LOSS TIME — s] for the maximum failure time. This corresponds to an unlimited automatic restart.

To withdraw the enable enter code "8888" again.

### 1.6.8 RS485 communication

2 protocols can be used via the serial interface of DELCOS 3100. In addition, different baud rates (4800, 9600, 19200Baud) and station addresses can be selected. The settings can be made in the [CONTROL MENU].

The DELCOS protocol is used in conjunction with the CompAir Profibus Module. DELCOS 3100 can be connected to a Profibus master (e.g. PLC) via the Profibus Module.

Modbus interfaces and the associated drivers are available for nearly all programmable logic controls (PLC) and for PC visualisation software by renown manufacturers.

### 1.7 Factory pre-set limit values

This menu allows you to check, but not to change, the factory settings programmed for your unit. Exception: <sup>1)</sup>.

Please note the following values, which are set individually to your unit:

<b>[LIMIT VALUES]</b>	
Design pressure	bar / psi
Start protection	bar / psi
Ext.Limit	rpm <sup>1)</sup>
Final temp warn	°C / °F
Final temp max	°C / °F
Min. start temp	°C / °F
Run-on time	s
Soft stop	s
Vol.Max.	m3/min <sup>1)3)</sup>
Vol.Min.	m3/min <sup>1)3)</sup>
Software:	

<sup>1)</sup> These values can be changed without entering a factory code.

<sup>2)</sup> The setting can be set to smaller values. It limits the adjustment options for the required line pressure in the menu [CONTROL] and results in a shutdown in the event of overpressure.

<sup>3)</sup> Values for the linear, speed-related calculation of the delivery volume shown.

### 2.1 Overview

The settings of the base load selection circuit (BLS) can be made in menu item [BASE LOAD SELECT], which is only displayed when the 'base load selection' option is installed. The BLS is an independent part of the normal compressor control of the master. It merely requires the following information from the master:

- Current line pressure
- Setting of the timer

It is therefore irrelevant, in which status the master machine is. The master can be switched off or even faulty. Only the following events result in a failure of the BLS:

- Master without power supply
- Fault: pressure sensor
- Warning: MS-Bus: A06 (relay module for controlling the slaves failed)

The terms below are used in the following description:

BLS:	Base load selection circuit
BLS series:	Order of compressors referred to the given line pressure switching points.
Slave:	Compressors K2 .. K5, which are switched to the on-load mode by a relay module.
Relay module A06:	Printed circuit board in the control cabinet of the master machine, which is provided with potential-free contacts for controlling the slaves and to which fault messages of the slaves can (optionally) be connected.
Cut-out point	Setting of BLS, which defines the upper limit of the pressure band.
Target pressure	Setting of the BLS, which is used by the speed-controlled unit (master) as a basis for controlling.
Cut-in point	This value results from the value set for cut-out point and target pressure. See 2.6.4 Setting [CUT-OUT POINT / TARGET PRESSURE].
Change-over time:	Determination, how long the current base load machine is to be maintained before the BLS series changes over. Compressors K2 to K5 receive on-load/off-load commands from the master control. To this end, a relay module is provided in the master control (see electrical circuit diagram). The relay contacts must be integrated into the control of the slaves so that a picked-up relay (contact made) causes the connected compressor to change to the on-load mode. In order that the normal on-load/off-load control of the machine has no influence on BLS operation, the switching points must be changed accordingly on each slaves.
Remaining time:	Indication, when the change-over of compressors will take place

### 2.2 Functional description / features

The line pressure range that is to be maintained by the base load selection circuit is defined by the setting [CUT-OUT POINT / TARGET PRESSURE] in the menu [BASE LOAD SELECT]. When the line pressure leaves this range or the demand for compressed air changes significantly, the control switches compressors on or off as required. Since the control establishes additionally, how fast the setpoint range is left, the compressors are cut in or out correspondingly slowly or fast. Further functions are described in conjunction with the individual setting options.

Features of the BLS:

- Independent operation, no failure of the station in the case of a fault or temporary deactivation of the master.
- In the case of a compressor fault, the subsequent compressors move up and the faulty compressor is reintegrated after the fault was eliminated (requires to connection of slave fault messages to the master machine).
- Status display of time remaining until change-over, on-load, off-load and fault of the compressors; the operator can call the status display additionally during normal operation without having to enter the BLS menu.
- Change-over time, remaining time and current base load series can be adjusted during operation
- Test routine (300s) and blockable change-over time (fixed BLS order)
- The change-over time is running during on-load operation of the base load unit
- With the help of parameter "LOAD NET IN XYMIN", it is possible to activate only a limited number of compressors for the classic "Monday morning start-up".
- It is possible to define reserve compressors that are not integrated in the BLS, but assigned as fixed "reserve" peak load compressors.
- Change-over of pressure possible via timer and/or external contact.
- The BLS cuts slave compressors out, when the flow reserve is sufficient to provide the delivery volume of these slave compressors. The status display shows the delivery volume of the individual units and/or the complete station.
- Adjustable start-up delay (for short line pressure breakdowns)
- The current delivery volume is output via an analogue output (OPTION)

---

## 2.3 Interfacing the slaves with the BLS

---

### 2.3.1 Load requirement

Compressors K2 to K5 receive on-load/off-load commands from relay module A06 of the BLS. A picked-up relay means on-load operation.

The relay contacts must be switched in the control of the slaves. In order that the normal on-load/off-load control of the machine has no influence on BLS operation, its setting must be changed accordingly.

### 2.3.2 Fault message

The fault messages of the slaves (K2..K5) can (optionally) be wired to existing terminals of the master relay module. A closed electric circuit means "no fault".

For compressors with DELCOS 3100 it is useful to wire back the message "operation". Otherwise, the "SWITCH OFF" function is faulty and the analogue output provides incorrect values (e.g. slave was switched off manually = not faulty => is requested and integrated into the calculation of the delivery volume).

---

## 2.4 Interfacing the master with the BLS

---

When the BLS is not switched on [OPERATION OFF] or failed [OPERATION—], the master machine (K1) is controlled on the basis of the line pressure switching points set in the menu [CONTROL].

As soon as the BLS is switched on [ON/TIMER], the master machine is coupled by the software to the BLS. On-load and off-load commands will then be provided exclusively by the BLS.

The fault message of the master (K1) is acquired internally and is therefore always available.

---

## 2.5 Remote control

---

The BLS can be switched on or off via external contacts, and the BLS or the machine itself can be switched to a second pressure range.

If the cable length between the machine and external contacts is longer than 20 m, coupling relays must be used.

### 2.5.1 Remote pressure change-over

The BLS can forcedly be changed over to the second pressure band via input E07.5 (module A06) (see chapter [TIMER CONTROL]).

While the pressure is being changed over, symbol  $p_2$  flashes before the indication of the current line pressure.

### 2.5.2 Remote switching off in [OPERATION ON]

The BLS can be temporarily switched off via input E07.4 (module A06).

This deactivation is not identical to manual switching off of the BLS. Only the load requirements to all machines are withdrawn. In contrast to manual switching off, the message "BLS active" is maintained.

### 2.5.3 Remote switching on in [OPERATION TIMER]

The BLS that was switched off via the timer can be force-activated via input E07.4 (module A06).

## 2.6 Overview [BASE LOAD SELECT.] menu

All of the settings in the menu can be locked/unlocked by entering the code 3031.

[BASE LOAD SELECT]		{Menu header}
OPERATION	ON	{OFF, ON, TIMER, fault}
CUT-OUT-POINT	13.0 bar	{Max. line pressure}
TARGET PRESSURE	12.5 bar	{Value used for controlling the line pressure}
BASE LOAD COMP.	2	{Current base load unit}
24h K1 K2 k3 k4 k5		{Status line: Remaining hours and series}
CHANGEOVER TIME	24h	{Setpoint time provided for the series}
QUANT. OF SLAVES	3	{For normal BLS operation}
QUANT. RESERVE	1	{As reserve for emergencies}
VOL. COMPR. 2 =	20.0 m <sup>3</sup> /min	{Delivery volume of compressor 2}
VOL. COMPR. 3 =	15.0 m <sup>3</sup> /min	{Delivery volume of compressor 3}
VOL. COMPR. 4 =	15.0 m <sup>3</sup> /min	{Delivery volume of compressor 4}
VOL. COMPR. 5 =	8.0 m <sup>3</sup> /min	{Delivery volume of compressor 5}
SWITCH OFF DELAY	30s	{Waiting time until cut-out}
START DELAY	5s	{Graduated start-up}
LOAD NET IN	15min	{Start-up velocity}
NET VOLUME	20m <sup>3</sup>	{Line volume}

### 2.6.1 Notes on the setting

This Base Load Selection circuit offers all possibilities of operating the compressed air system in the most effective way.

It allows smallest pressure bands with highest precision, lowest pressure level, etc. At the same time, the unnecessary activation of compressors, caused, for example, by irrelevant line pressure breakdowns over a very short period of time, is prevented.

On the other hand, certain conditions may be present, which are not optimal, but cannot be avoided (e.g. installed compressor with long start-up time). Moreover, the compressed air receiver may be too small or line losses (leakage) too great. A lot of other reasons could be listed here.

The corresponding setting of the BLS is therefore, of course, the most important point. The data should be set as correctly and realistically as possible, and the optimum setting must be gradually approached.

### 2.6.2 Data saving

The settings of the BLS are battery-backed against loss. Battery-protection is only important for the de-energised phase of the machine.

Long before the battery is no longer able to protect the data, a warning appears on the display: BATTERY. In this case, the clock module (RTC) of the electronics must soon be replaced.

When the battery is completely exhausted, that data will be lost after a power failure. In order to ensure the compressed air supply also in this case, the BLS will change over to its default values. The unit-specific data can be adjusted temporarily (only until the next power failure).



**2.6.3 Setting [OPERATION]**

Here, the BLS is switched on or off. When the BLS failed as a result of the events described before, [OPERATION —] appears on the display until the fault is rectified. In this case, it is possible to switch from [OPERATION —] back to [OPERATION OFF]. When the BLS is switched off, no load requirements are sent to the slaves.

The compressors connected to the BLS can be controlled in dependence on the [TIMER]. The BLS receives the timer information from the menu [TIMER CONTROL] of the master, which must be programmed accordingly. The timer setting is/can be used by the BLS (menu: [BASE LOAD SELECT]) and/or the machine itself (menu: [CONTROL]).

The timer LED on the operator control membrane is reserved exclusively for the machine and does therefore not signal that the BLS is timer-controlled.

If a clock defect is recognised after a power failure, the BLS is switched back from [TIMER] to [ON]. The following message appears on the display [WARNING: BATTERY].

Since the BLS issues only on-load/off-load commands, it is assumed that all machines involved are switched on or in the stand-by mode (waiting for pressure requirement). This is also valid for the master machine itself.

**2.6.4 Setting [CUT-OUT POINT / TARGET PRESSURE]**

Line pressure range that is maintained by the BLS. The difference between cut-out point and target pressure cannot be set to a value smaller than 0.3 bar. This pressure band should not be set too small, in particular in the case of small line volumes, in order to ensure that the control operates as smoothly as possible.

The internal value for the cut-in point results from the setting of [CUT-OUT POINT] and [TARGET PRESSURE]. If the line pressure falls below the cut-in point, the BLS compressor cuts in. The CUT-IN POINT is calculated as follows:

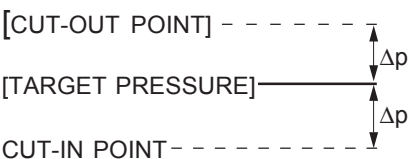

When a pressure change-over is activated in the menu [TIMER CONTROL] or the pressure change-over is initiated via the external contact, the BLS uses the values [ $p_2$  CUT-OUT POINT = xx BAR] and [ $p_2$  TARGET PRESSURE = xx BAR] from the menu [TIMER CONTROL].

When the line pressure leaves the desired range, the compressors are switched on or off as required.

**2.6.5 Setting [BASE LOAD COMP]**

The speed-controlled compressor firmly takes the first position. The base load machine can therefore only be set within the range of 2..(number of BLS slaves).

When a fault is detected on the base load unit, another compressor assumes (temporarily) the base load. The actual base load series is indicated on the status display, which is described in the following. When the fault is eliminated, the planned machine re-assumes the base load.

A change in the setting has no effect on the time remaining until the next change-over of the BLS series.

### 2.6.6 Status display of the BLS [123h K1 K3 k4 k2 r5]

The status display provides information about the current BLS order, the time remaining until the next change-over and the status of the machines (on-load/off-load/fault). The reserve machines are shown as well.

**Example:**

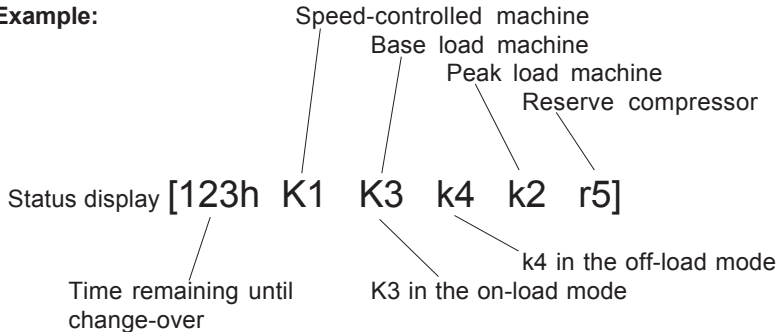

The time remaining until change-over can be changed within the range of 1h...change-over time in the input mode (exceptions: [CHANGE-OVER TIME 300s] or [CHANGE-OVER TIME—h] set). The change-over time is counted down as long as the base load unit is in the on-load mode.

The indication of the BLS series starts on the left with the speed-controlled machine, followed by the current base/medium/peak load machines and the reserve compressors. The following is shown:

- 'K2' Compressor 2 in the on-load mode
- 'k2' Compressor 2 in the off-load mode
- 'k!' Compressor faulty and moved to the last position, the display alternates every second between 'k2' and 'k!'

The same display structure is valid for reserve machines, however, with the letters "R/r" (instead of "K/k").

To get a quick overview of the BLS status during normal operation of the machines, you can show and hide this status display with the help of key . Since this is possible outside the menu, the change-over time cannot be changed here. The status display is maintained for max. 60 s in the display or is overwritten by any faults/warnings that occur.

### 2.6.7 Setting [CHANGE-OVER TIME]

Here, you can enter the setpoint time for the BLS series. The change-over time is counted down when the base load unit is running in the on-load mode. It stops when no compressor is requested.

The change-over time can be set within the range of 300s, 1h .. 999h, —h.

- 300s: Test mode
- 1h .. 999h: Normal change-over time
- h: No change-over; the BLS series is maintained permanently

In the test mode (300s) or if no change-over is requested (—h), the remaining time until change-over cannot be changed in the status display.

When the change-over time is shortened, this may have an effect on the BLS change-over time. As described before, the time remaining until change-over is only displayed on the BLS status display and can be changed there.

### 2.6.8 Setting [QUANT. OF BLS SLAVES]

Here, you can set, how many slave machines apart from the master are to be included in the actual BLS circuit, i.e. exchange the base load in dependence upon the operating hours. This does not apply to reserve machines.

### 2.6.9 Setting [QUANT. OF RESERVE]

If the number of BLS slaves is less than 4, reserve machines can be defined. The reserve machines are not included in the operating hours-related BLS circuit. They are always at the last position in the series and are cut in only when required. Typical reserve machines are, for example, outdated compressors, which are operable, but should be cut in in emergency cases only.

### 2.6.10 Setting [VOL.COMP 2..5]

The delivery volume of the slave compressors can be set here. Enter the delivery volume exclusively in the unit [m³/min].

### 2.6.11 Setting [SWITCH OFF DELAY]

The BLS knows all delivery volumes of the slave compressors and the current delivery volume of the speed-controlled machine. If the calculation shows that the speed-controlled compressor has a sufficient delivery volume available to assume the delivery value provided by the current peak load machine, the time set in [SWITCH OFF DELAY xy s] is counted down. The peak load machine is switched off after this period.

The peak load machine can be a slave or a reserve compressor.

We recommend that the value set here be not too short in order that the new operating point can be set after the peak load machine was cut out.

### 2.6.12 Setting [START DELAY]

The setting of the start-up delay (adjustment range 5..30s) allows a delayed reaction to line pressure break-downs. It causes the machines to be cut in one after the other. The set value should be at least the longest start/ delta time of the connected compressors.

When the pressure falls below CUT-IN POINT, the first unit is cut in without delay.

### 2.6.13 Setting [LOAD NET IN]

[LOAD NET IN xymin] is used to start only the number of compressors, which are required to charge the line in the specified time. In this way, automatic cutting in of the entire station is prevented.

This function is not active after a power failure. In this (emergency) case, cutting in takes place as usual.

When the compressors connected to the BLS circuit are started manually [OPERATION ON], via the timer or by remote control, while the current line pressure is below TARGET PRESSURE, the compressed air line is charged in a controlled manner.

Example:

On Monday morning at 6:00 o'clock, the compressed air mains must have a pressure of 8.0bar. In order to minimise, amongst others, the reactive power requirement, as few compressors as possible should be switched on.

Solution:

The master compressor is activated by its timer at 5:45 o'clock for switching on the BLS. The BLS mode is set to "timer" and "load net" to 15 min. After 15 minutes at the latest will a line pressure of 8.0 be reached and the number of compressors cut in for this is kept to a minimum.

### 2.6.14 Setting [NET VOLUME]

To calculate the ideal control characteristics, the BLS must know the net volume of the compressed air station. Enter the sum of all receivers here.

Caution:

- The correct setting of the parameter [NET VOLUME] is decisive for a satisfactory operation of the base load selection circuit!
- Setting too small (slow): In the case of significant changes in the consumption, the BLS cannot recognise within the range of TARGET PRESSURE and CUT-OUT POINT that it must preventively cut out compressors.
- Setting too high (sensitive): The BLS cuts compressors out too early within TARGET PRESSURE and CUT-OUT POINT.

## 2. Base load selection circuit DELCOS 3100 LSR

### 2.7 Change-over of BLS series

When the change-over time has elapsed, changing over to the new series takes place, and the time remaining until the next change-over is re-set to the value specified in [CHANGEOVER TIME]. The reserve compressors remain at the peak load position.

Example:                    2 slave compressors                    4 BLS compressors  
                                   2 reserve compressors                    No reserve compressor possible

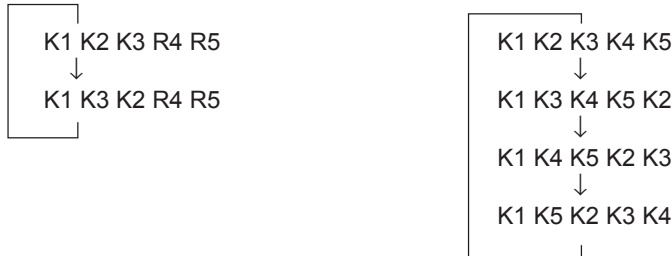

When changing over takes place, not only the line pressure switching points, but also the previous load enables are passed on.

### 2.8 Compressor fault

Faults of slaves can only be considered, if their fault message contacts are wired to the relay module.

In the event of a fault of a compressor, the latter is shifted to the last position in the series and the load enable is withdrawn. The available compressors that are not faulty move up in the series. After the fault was rectified, the compressor(s) are re-integrated in the BLS series.

Example 1: Circuit with 4 compressors, 1 reserve compressor, [BASE LOAD COMP. 3], fault of K4

Before the fault:    103h K1 K3 K4 k2 r5    {K3+K4 on load}  
 Fault of K4:        103h K1 K3 K2 r5 k!    {K3+K2 on load}  
 After the fault:    102h K1 K3 K4 k2 r5

When the BLS series is changed over, the new BLS series is re-arranged with the available machines.

Example 2: Circuit with 4 compressors, 1 reserve compressor, [BASE LOAD COMP. 3], [CHANGEOVER TIME 250h], K4 faulty

Before the fault:    14h K1 K3 K4 k2 r5    {K3+K4 on load}  
 Fault of K4:        14h K1 K3 K2 r5 k!    {K3+K1 on load}  
 Change-over:        250h K1 K2 K3 r5 k!    {K4 is now the planned base load compressor, but faulty}  
 After the fault:     217h K1 K4 K2 k3 r5    {K4 re-integrated after the fault}

## 2.9 Message BLS active

The slave compressors are usually provided with their own/internal pressure switch for on-load/off-load control. In conjunction with coupling relays, the message "BLS active" can be used to disconnect the slaves from their internal pressure switches, i.e. controlling takes place exclusively via the load request from the master.

Should the BLS fail, can the slave change over to its own pressure switch.

### 2.9.1 Via the output Spare-Out (option)

The function BLS active can be activated via the Spare-Out of the master using code 9348. When the BLS is active [OPERATION ON/TIMER] the relay is picked up. The relay drops out, when, due to the following events on the part of the BLS master, load enables can no longer be passed on to the machines [OPERATION OFF/—]:

1. The BLS was switched off in the menu
2. Master without power supply
3. Fault: Line pressure sensor B1
4. Warning: MS-Bus: A06 (relay module for controlling the slaves failed)

### 2.9.2 Via the BLS module

If the total number of slaves and reserve machines is less than 4, one relay on relay module A06 is free. This relay assumes the function of signalling BLS active. The Spare-Out can therefore be used for other messages.

## 2.10 Messages to the higher-level system when BLS is not activated

If the quantity of slaves + quantity reserve = 0 and the BLS operation = OFF, the relay outputs of the BLS module signal the following:

Relay A06.0	The speed-controlled machine is 100% under full load
Relay A06.1	The speed-controlled machine is off load
Relay A06.2	The speed-controlled machine is on load
Relais A06.3	Reserved

## 3 Analogue output (option)

The optional analogue output module is provided with two 4..20mA outputs.

Channel no.	Scaling 4..20mA
1	0..maximum speed
2	0..maximum flow <sup>1)</sup>

- 1) When BLS is active, this corresponds to the sum of all compressors controlled by BLS.

### Note

*To provide galvanic isolation, an isolation amplifier is to be provided directly downstream of the analogue outputs.*

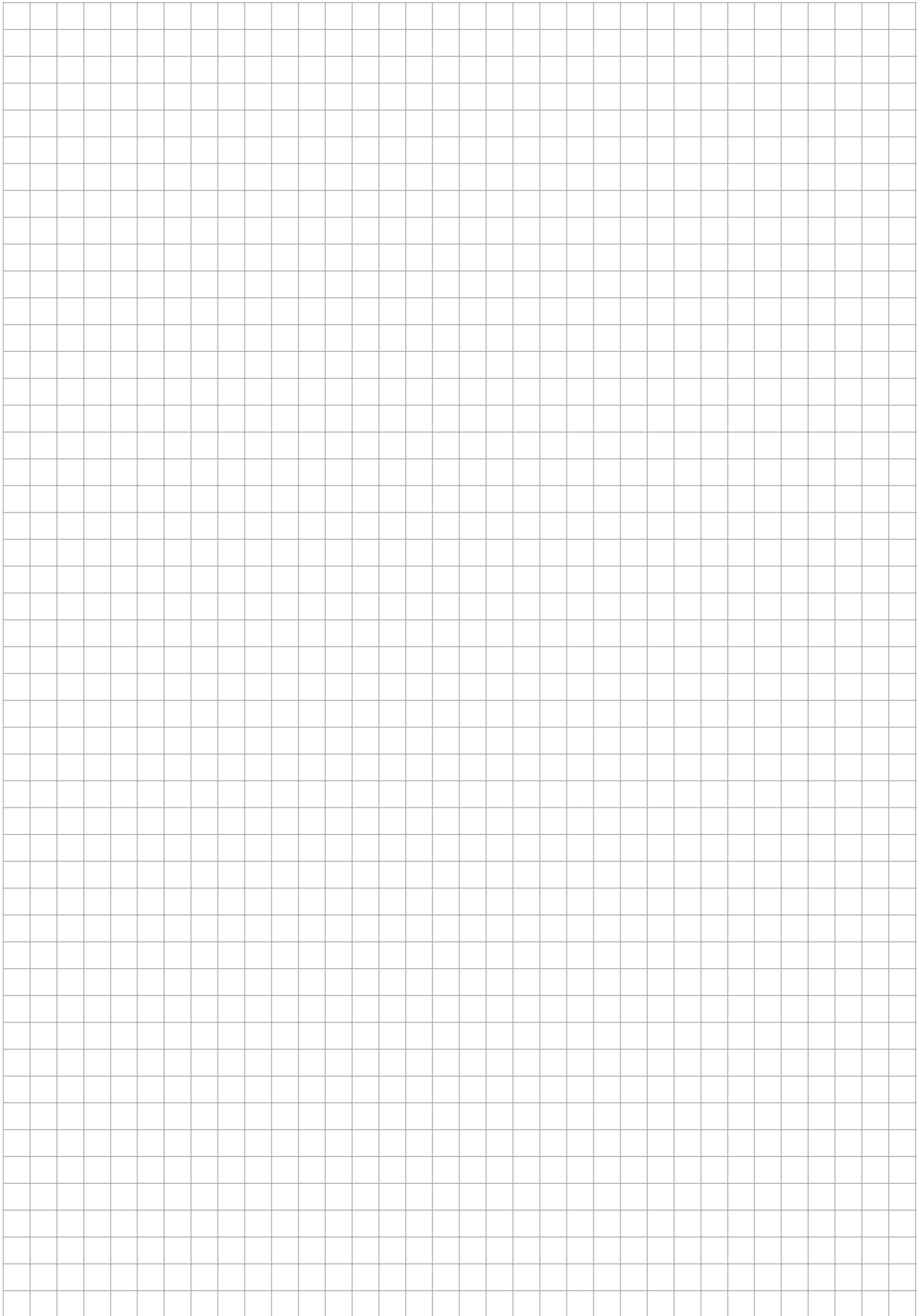



**CompAir Drucklufttechnik GmbH  
Argenthaler Str. 11  
55469 Simmern  
Deutschland**

**Tel. +49 (0) 6761 832-0**